

AM3168 – Filter Bank

Analog Tunable 13 GHz to 16 GHz and 16 GHz to 19 GHz Notch

AM3168 is an analog voltage-tunable notch filter bank covering the 13 GHz to 19 GHz frequency range. The device offers two bands from 13 GHz to 16 GHz and 16 GHz to 19 GHz for continuous notch frequency tuning within its operating range. Only one tune voltage input is required providing simple and precise control of the notch frequency. The AM3168 provides an excellent filtering solution for a receiver or transceiver requiring flexible frequency removal, high dynamic range, low insertion loss, and small size, weight, and power consumption (low SWaP).

FEATURES

- Analog Tuning
- 1 dB Typical Insertion Loss
- 35+ dB Typical Rejection
- BW 20% of Tuned Frequency, TYP
- 0.0V to +8.0V Tuning Voltage Range
- 5mm QFN Package
- -40C to +85C Operation

FUNCTIONAL DIAGRAM

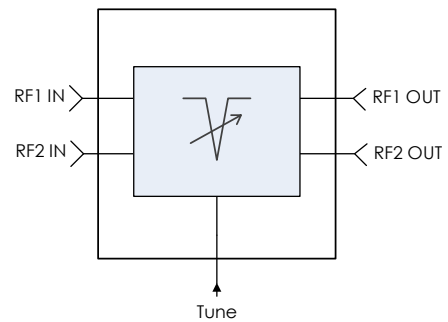

CHARACTERISTIC PERFORMANCE

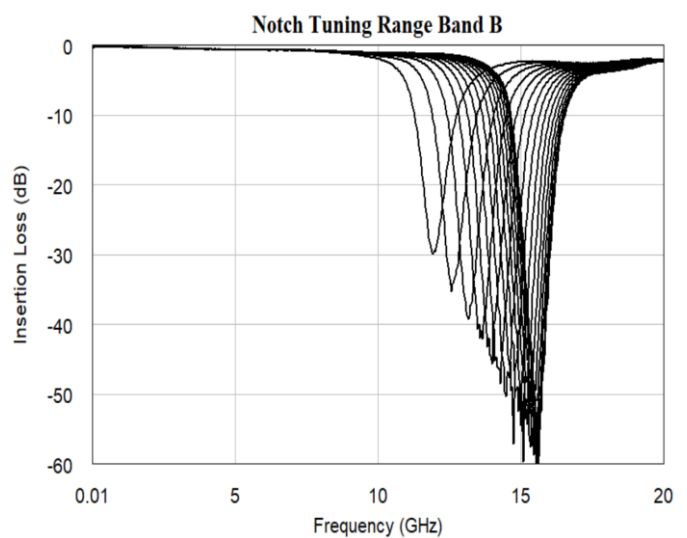
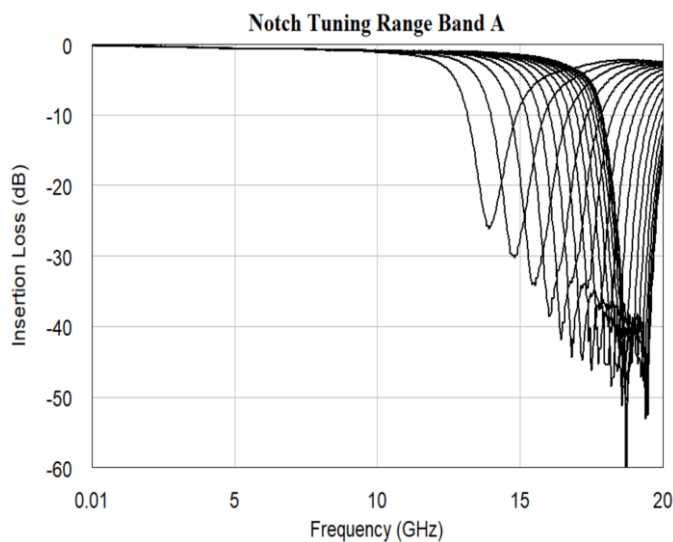

CONTENTS

REVISION HISTORY..... 2

PIN LAYOUT AND DEFINITIONS 3

SPECIFICATIONS..... 4

STATE TABLE 6

TYPICAL PERFORMANCE 7

TYPICAL APPLICATION..... 8

EVALUATION PC BOARD..... 9

RELATED PARTS..... 9

COMPONENT COMPLIANCE INFORMATION10

REVISION HISTORY

Date	Revision	Notes
4/17/2025	1	Initial Revision

PIN LAYOUT AND DEFINITIONS

Note: All Non-Named Pins are NC or GND

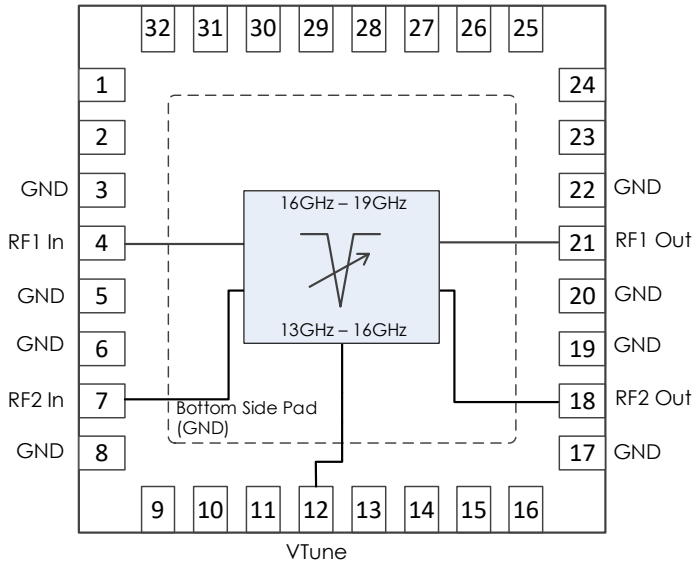

Pin	Name	Function
1, 2	NC	Not Connected*
3	GND	Ground - Common
4	RF1 In	Band A RF Input - 50 Ohms - DC Coupled. Internally connected to GND. No external DC blocking capacitor required unless a nonzero voltage is present
5, 6	GND	Ground - Common
7	RF2 In	Band B RF Input - 50 Ohms - DC Coupled. Internally connected to GND. No external DC blocking capacitor required unless a nonzero voltage is present
8	GND	Ground - Common
9-11	NC	Not Connected*
12	VTune	Notch Tune Voltage
13-16	NC	Not Connected*
17	GND	Ground - Common
18	RF2 Out	Band B RF Output - 50 Ohms - DC Coupled. Internally connected to GND. No external DC blocking capacitor required unless a nonzero voltage is present
19, 20	GND	Ground - Common
21	RF1 Out	Band A RF Output - 50 Ohms - DC Coupled. Internally connected to GND. No external DC blocking capacitor required unless a nonzero voltage is present
22	GND	Ground - Common
23-32	NC	Not Connected*

Note: NC pins may be grounded or left floating.

SPECIFICATIONS

Absolute Maximum Ratings

	Minimum	Maximum
DC Control Voltage	0.0V	+10.0 V
RF Input Power		+27 dBm
Storage Temperature Range	-55 C	+150 C

Note: Any device operation beyond the Absolute Maximum Ratings may result in permanent damage to the device. The values listed in this table are extremes and do not imply functional operation of the device at these or any other conditions beyond what is listed under Recommended Operating Conditions. Any part subjected to conditions outside of what is recommended for an extended amount of time may suffer from reliability concerns.

Handling Information

	Minimum	Maximum
Moisture Sensitivity Level	MSL 3	



Mercury products are electrostatic sensitive.
Follow safe handling practices to avoid damage.

Recommended Operating Conditions

	Minimum	Typical	Maximum
DC Control Voltage	0.0 V		+8.0V
Operating Case Temperature	-40 C		85 C

DC Electrical Characteristics

(T = 25 °C unless otherwise specified)

Param	Testing Conditions	Min	Typical	Max
DC Control Voltage		0.0 V		+8.0 V
DC Control Current			<1mA	

RF Performance

(T = 25 °C unless otherwise specified)

Param	Testing Conditions	Min	Typical	Max
Frequency Range	Band A	16 GHz		19 GHz
Frequency Range	Band B	13 GHz		16 GHz
Insertion Loss			1.0 dB	
Notch Depth			35 dB	
Return Loss			-15 dB	
Input IP3			+40 dBm	

STATE TABLE

(T = 25 °C unless otherwise specified)

Notch Filter Typical Center Frequencies		
Tune Voltage (V)	Band A (GHz)	Band B (GHz)
0.0	13.9	11.9
1.0	15.5	13.2
2.0	16.6	13.9
3.0	17.3	14.5
4.0	18.0	14.9
5.0	18.5	15.2
6.0	18.9	15.4
7.0	19.1	15.5
8.0	19.2	15.6

TYPICAL PERFORMANCE

(T = 25°C unless otherwise specified)

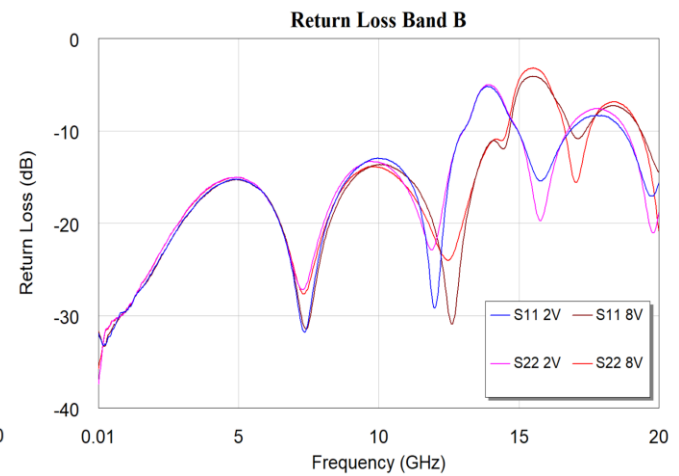
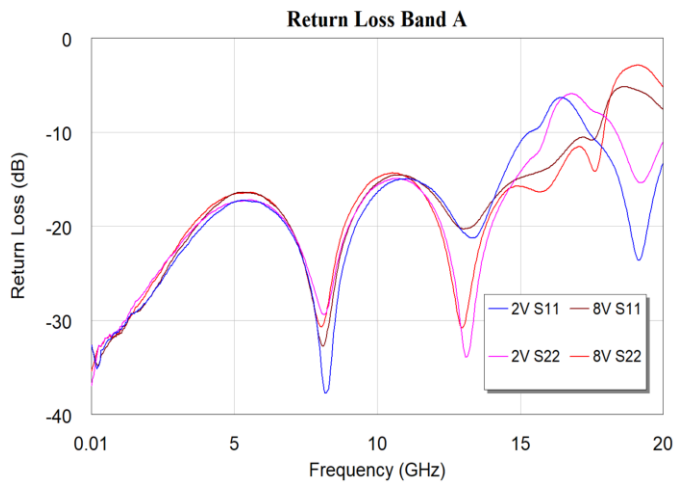
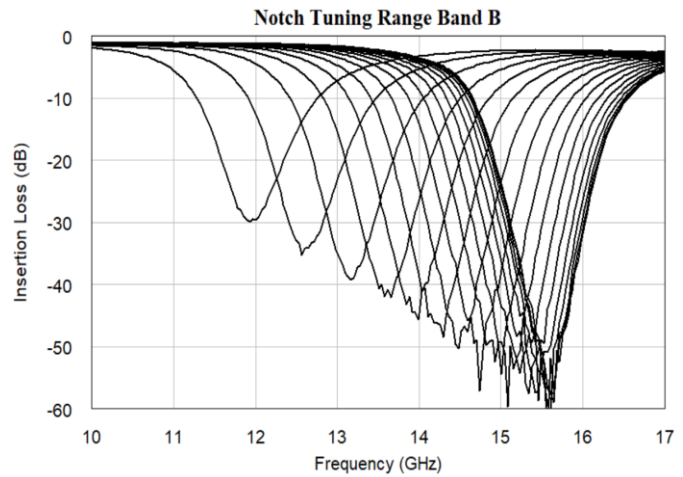
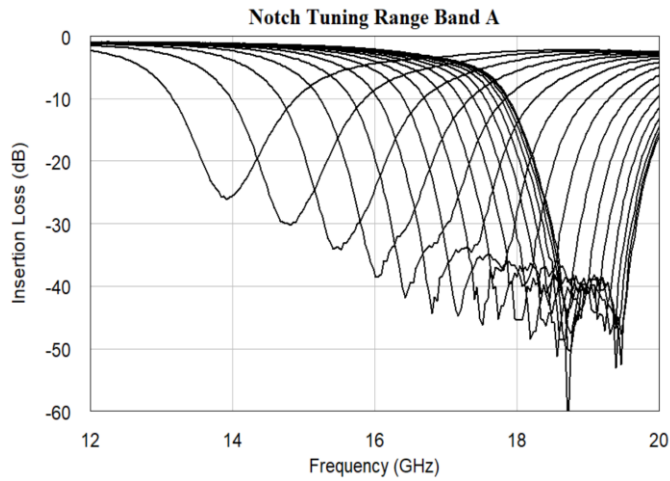

NOTE: Only some states shown for simplicity

TYPICAL APPLICATION

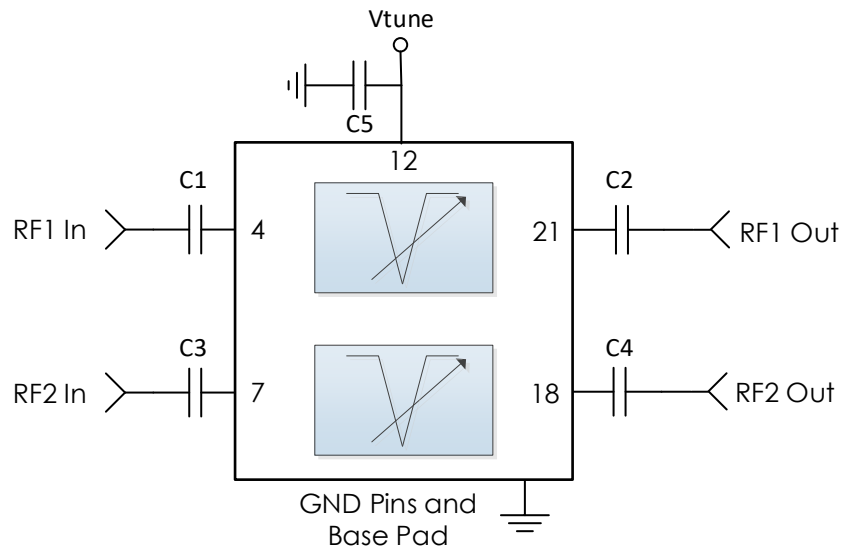

RECOMMENDED COMPONENT LIST (OR EQUIVALENT)

Part	Value	Part Number	Manufacturer
C1 - C4	0.1 uF	0201BB104KW160	Passive Plus
C5	100 pF	GRM1555C1H101JA01D	Murata

Note:

1. C1 - C4 required if nonzero voltage present on RF paths.
2. Filtering on tune voltage line is recommended to prevent digital noise from coupling to RF path.
 - a. Select C value based on desired logic source decoupling and switching speed. There is a 20 kOhm resistor internally in series for Band A and a 20 kOhm resistor internally in series for Band B.

EVALUATION PC BOARD

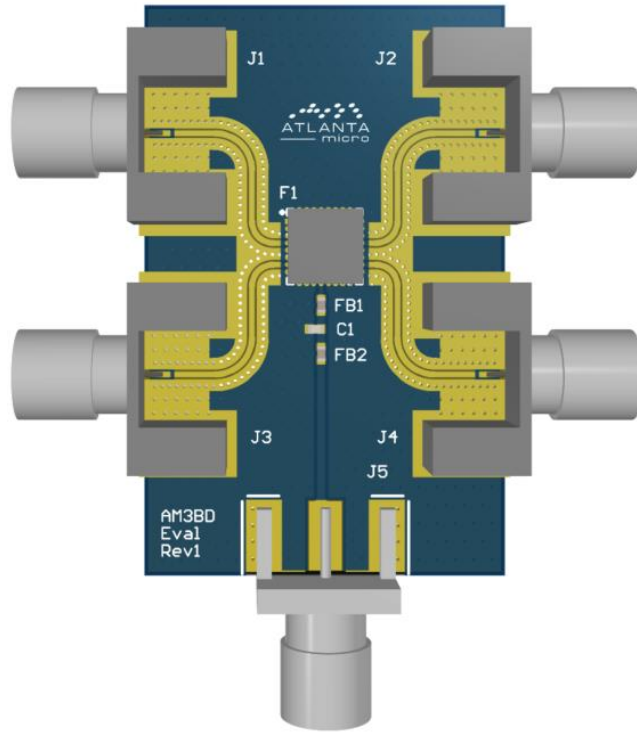

RELATED PARTS

Part Number	Description			
AM3166	9 GHz	to	19 GHz	Analog Tunable Notch Filter Dual Package
AM3167	11 GHz	to	16 GHz	Analog Tunable Notch Filter Dual Package
AM3169	5.5 GHz	to	10 GHz	Analog Tunable Notch Filter Dual Package

COMPONENT COMPLIANCE INFORMATION

RoHS: Mercury Systems, Inc. hereby certifies that all products comply with the EC Directive 2011/65/EC on the Restriction of Hazardous Substances, commonly known as EU-RoHS 6 and 10. All products supplied by Mercury shall be compliant with the European Directive 2011/65/EC based on the following substance list.

Substance List	Allowable Maximum Concentration
Lead (Pb)	<1000 PPM (0.1% by weight)
Mercury (Hg)	<1000 PPM (0.1% by weight)
Cadmium (Cd)	<75 PPM (0.0075% by weight)
Hexavalent Chromium (CrVI)	<1000 PPM (0.1% by weight)
Polybrominated Biphenyls (PBB)	<1000 PPM (0.1% by weight)
Polybrominated Diphenyl ethers (PBDE)	<1000 PPM (0.1% by weight)
Decabromodiphenyl Deca BDE	<1000 PPM (0.1% by weight)
Bis (2-ethylhexyl) Phthalate (DEHP)	<1000 PPM (0.1% by weight)
Butyl Benzyl Phthalate (BBP)	<1000 PPM (0.1% by weight)
Dibutyl Phthalate (DBP)	<1000 PPM (0.1% by weight)
Diisobutyl Phthalate (DIBP)	<1000 PPM (0.1% by weight)

REACH: Mercury Systems, Inc. neither uses nor intentionally adds any of the substances considered to be a Substance of Very High Concern (SVHC) as defined by the EU Regulation (EC) No. 1907-2006 on Registration, Evaluation, Authorization, and Restriction of Chemicals (REACH).

Conflict Materials: Mercury does not knowingly use materials that are sourced from the Democratic Republic of Congo (DRC) or any other known conflict regions. Mercury’s supply chain is comprised of sources that are both environmentally and socially responsible. We periodically review this requirement with our vendors to ensure continued compliance.

Mercury takes its responsibility as a global partner seriously and will use due diligence within our supply chain to ensure all standards are met to the best of our knowledge.



Corporate Headquarters

50 Minuteman Road
 Andover, MA 01810 USA
 +1 978.967.1401 tel
 +1 866.627.6951 tel
 +1 978.256.3599 fax

International Headquarters

Mercury International
 Avenue Eugène-Lance, 38
 PO Box 584
 CH-1212 Grand-Lancy 1
 Geneva, Switzerland
 +41 22 884 5100 tel

Learn more

Visit: mrcy.com

For pricing details, contact: MMICsales@mrcy.com

For technical details, contact: MMICsupport@mrcy.com



The Mercury Systems logo is a registered trademark of Mercury Systems, Inc. Other marks used herein may be trademarks or registered trademarks of their respective holders. Mercury products identified in this document conform with the specifications and standards described herein. Conformance to any such standards is based solely on Mercury’s internal processes and methods. The information contained in this document is subject to change at any time without notice.

