

# AM1162-D – Amplifier

## 24 to 40 GHz Low Noise Amplifier

**AM1162-D is a wideband, cascadable amplifier servicing the 24 to 40 GHz frequency range.** The device exhibits high gain and excellent noise figure using a single supply at 5V and 71mA. The low noise figure and high gain in conjunction with its excellent gain flatness makes the AM1162-D a useful component for many Ka band satcom applications. Available as bare die in a 2.10mm x 1.34mm footprint with internal 50Ω matching and DC blocking capacitors, the AM1162-D is a small form-factor solution that can enable low SWaP applications.

### FEATURES

- 21 dB Gain
- 2.1 dB Noise Figure
- +21 dBm OIP3
- +11 dBm P1dB
- +5V/71 mA Operation
- 2.10mm x 1.34mm Bare Die
- -40C to +85C Operation

### FUNCTIONAL DIAGRAM

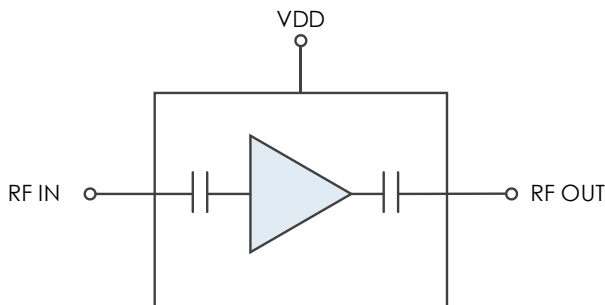

### CHARACTERISTIC PERFORMANCE

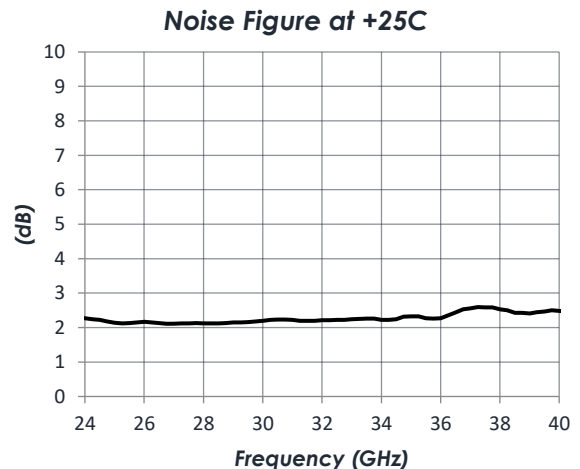
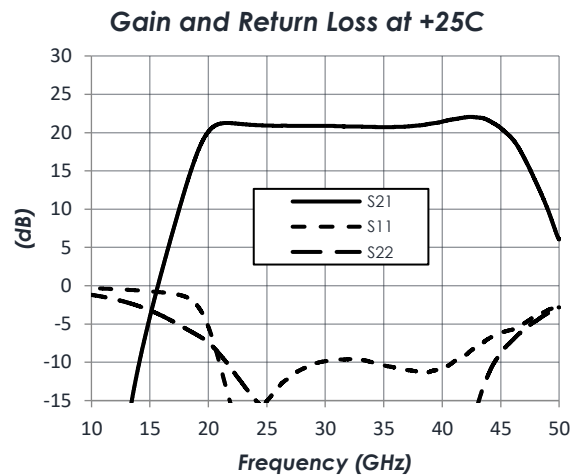

CONTENTS

FEATURES ..... 1

FUNCTIONAL DIAGRAM ..... 1

CHARACTERISTIC PERFORMANCE ..... 1

REVISION HISTORY ..... 2

PIN LAYOUT AND DEFINITIONS ..... 3

SPECIFICATIONS ..... 4

TYPICAL PERFORMANCE ..... 5

TYPICAL APPLICATION ..... 7

DIE DIMENSIONS ..... 8

PART ORDERING DETAILS ..... 8

RECOMMENDED WIRE BONDS ..... 9

RELATED PARTS ..... 9

COMPONENT COMPLIANCE INFORMATION ..... 10

REVISION HISTORY

Date	Revision	Notes
July 25, 2024	1	Initial Release

PIN LAYOUT AND DEFINITIONS

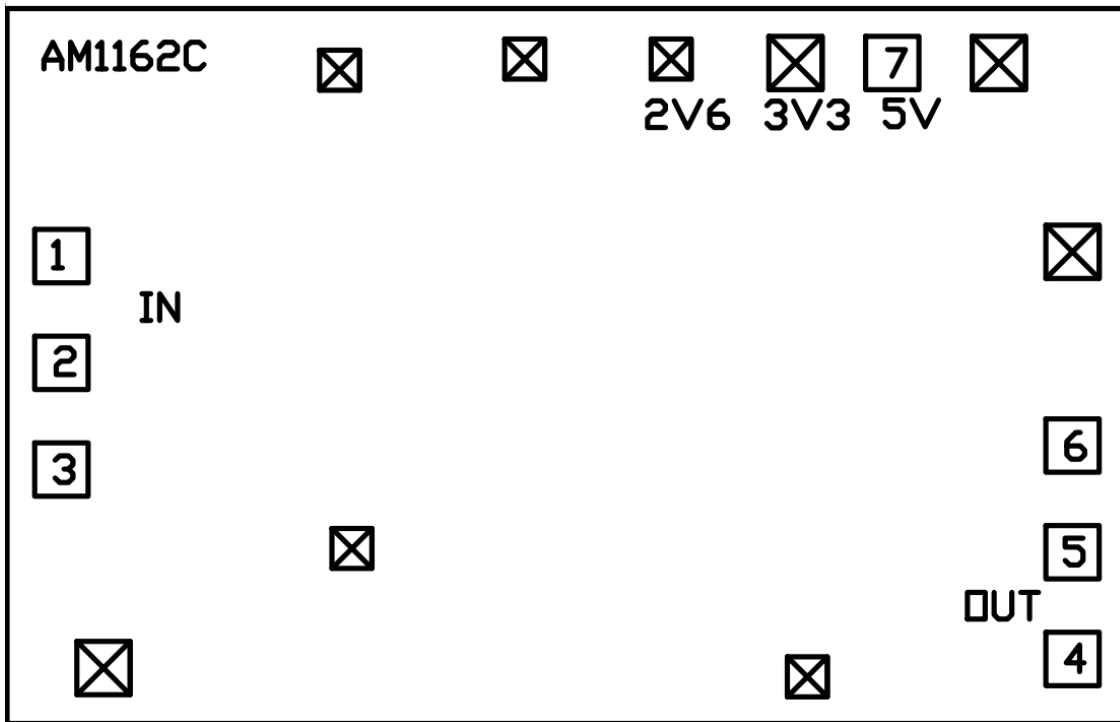

Pin	Name	Function
1	GND	Ground - Common
2	RF In	RF Input - 50 Ohms - AC Coupled
3	GND	Ground - Common
4	GND	Ground - Common
5	RF Out	RF Output - 50 Ohms - AC Coupled
6	GND	Ground - Common
7	5V	DC Power Input

## SPECIFICATIONS

### Absolute Maximum Ratings

	Minimum	Maximum
Supply Voltage	-0.3 V	+5.2 V
RF Input Power		10 dBm
Storage Temperature Range	-55 C	+150 C

**Note:** Any device operation beyond the Absolute Maximum Ratings may result in permanent damage to the device. The values listed in this table are extremes and do not imply functional operation of the device at these or any other conditions beyond what is listed under Recommended Operating Conditions. Any part subjected to conditions outside of what is recommended for an extended amount of time may suffer from reliability concerns.

### Handling Information

	Minimum	Maximum
ESD Sensitivity – Human Body Model (HBM)	Class 0A	



Mercury products are electrostatic sensitive. Follow safe handling practices to avoid damage.

### Recommended Operating Conditions

	Minimum	Typical	Maximum
Supply Voltage		+5 V	
Operating Case Temperature	-40 C		+85 C

### Thermal Information

Thermal Resistance (channel to backside ground)	132 C/W
Nominal Junction Temperature at +85C Ambient	134 C
Channel Temperature to Maintain 1 Million Hour MTTF	175 C

### DC Electrical Characteristics

(T = 25 °C unless otherwise specified)

Param	Testing Conditions	Min	Typical	Max
DC Supply Voltage			+5 V	
DC Supply Current	VDD = +5 V	67 mA	71 mA	75 mA
Power Dissipated	VDD = +5 V		355 mW	

### RF Performance

(T = 25 °C unless otherwise specified)

Param	Testing Conditions	Min	Typical	Max
Frequency Range		24 GHz		40 GHz
Gain	f = 24 GHz		21 dB	
	f = 32 GHz		20.8 dB	
	f = 40 GHz		21.3 dB	
Return Loss	f = 24 GHz		-15 dB	
	f = 32 GHz		-10 dB	
	f = 40 GHz		-10 dB	
Output IP3	f = 32 GHz		21 dBm	
Output P1dB	f = 32 GHz		10.9 dBm	
Noise Figure	f = 32 GHz		2.2 dB	

Notes:

- OIP3 measured with -24dBm input power tones at 10MHz spacing

TYPICAL PERFORMANCE

(VDD = +5V, T = 25 °C unless otherwise specified)

Gain vs Temperature

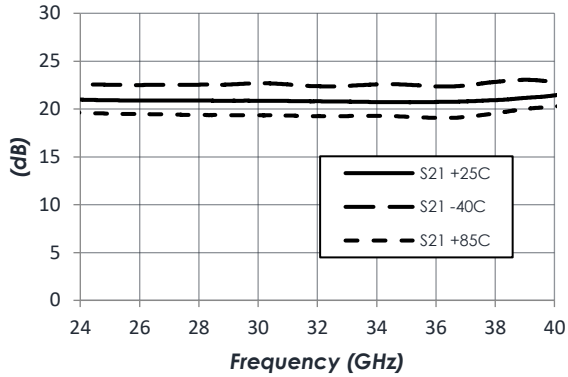

Noise Figure vs Temperature

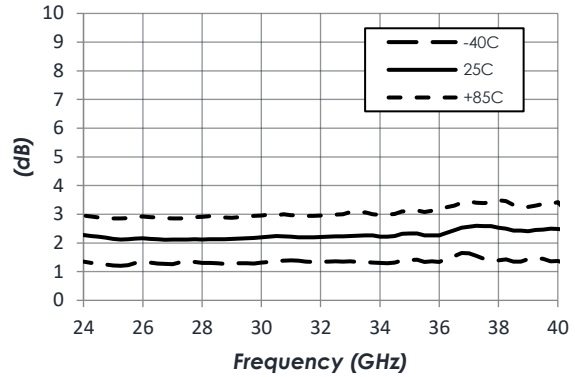

Output IP3 vs Temperature

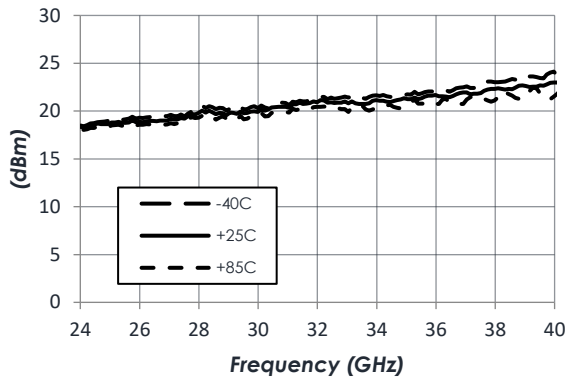

P1dB vs Temperature

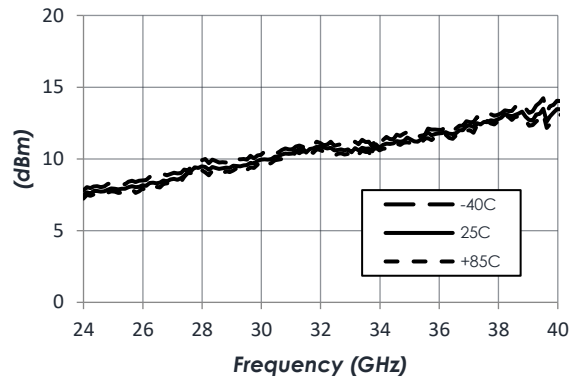

Reverse Isolation vs Temperature

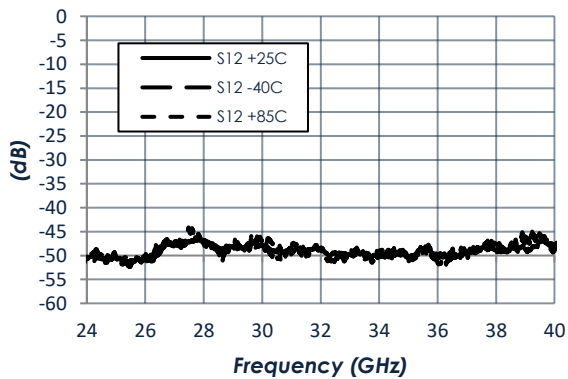

TYPICAL PERFORMANCE (continued)

(VDD = +5V, T = 25 °C unless otherwise specified)

Power Saturation

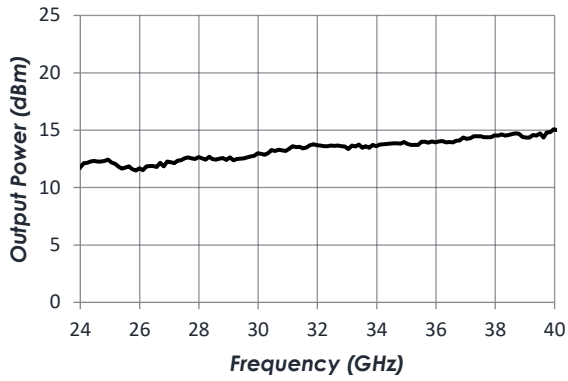

Pin vs. Pout at +25C

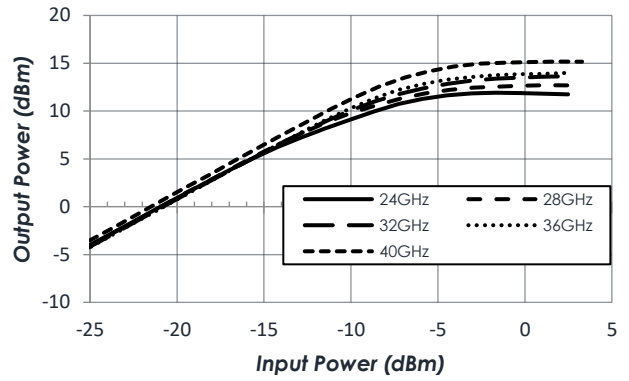

TYPICAL APPLICATION

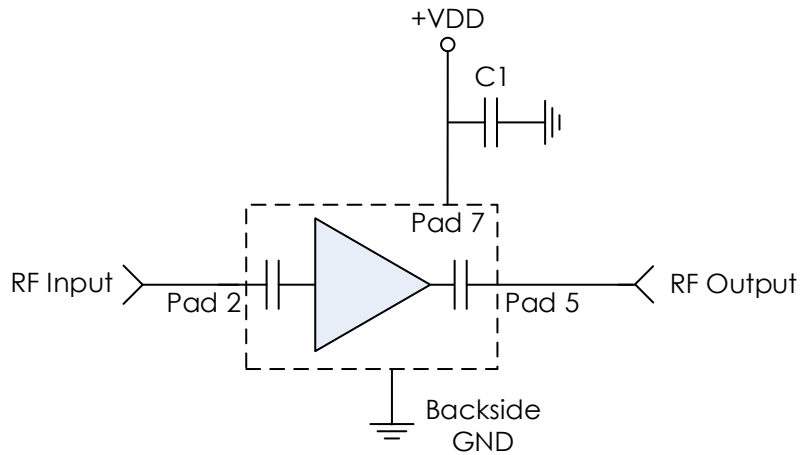

RECOMMENDED COMPONENT LIST (OR EQUIVALENT)

Part	Value	Part Number	Manufacturer
C1	100 pF	SKT01A101Z10A6	Tecdia

Notes:

1. AM1162-D is AC coupled. No external DC blocking capacitors are required.

DIE DIMENSIONS

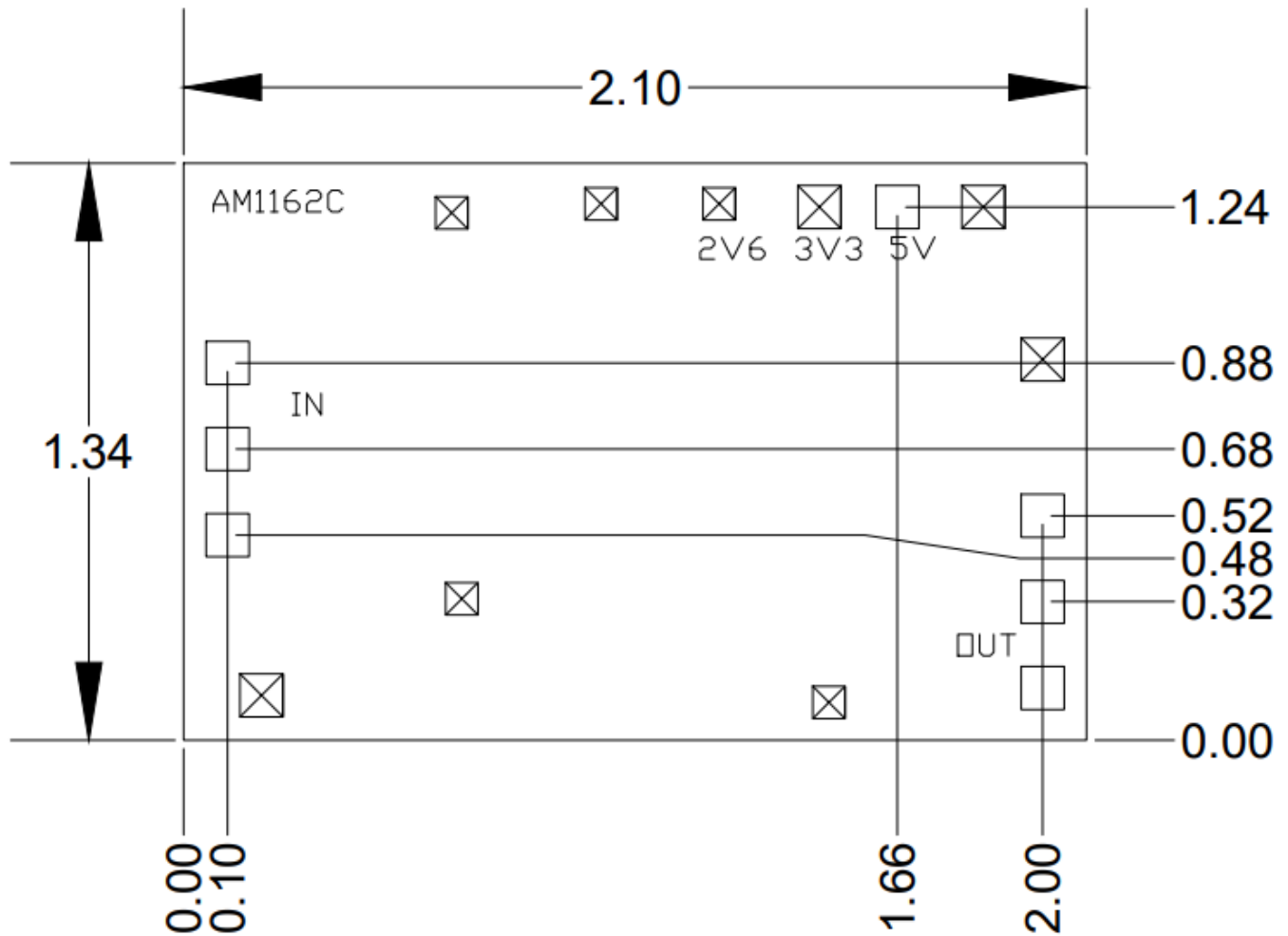

PART ORDERING DETAILS

Description	Part Number
2.10mm x 1.34mm Bare Die	AM1162-D



RECOMMENDED WIRE BONDS

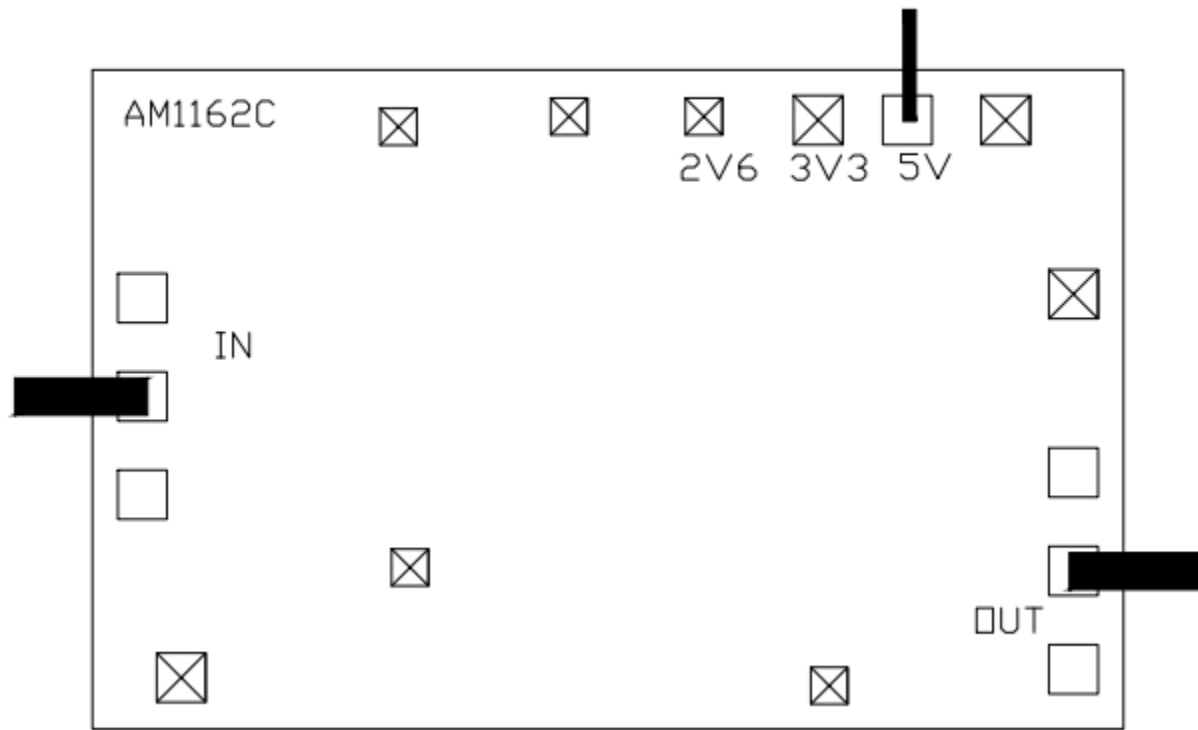

Notes:

1. RF input and output pads should use minimum length 3 x 0.5mil ribbon bonds for optimum performance.
2. DC bonds should be 1 mil, gold.

RELATED PARTS

Part Number		Manufacturer
AM1144	17 GHz to 40 GHz	Driver Amplifier
AM1168	15 GHz to 40 GHz	Driver Amplifier
AM1172	18 GHz to 50 GHz	Driver Amplifier

COMPONENT COMPLIANCE INFORMATION

**RoHS:** Mercury Systems, Inc. hereby certifies that all products comply with the EC Directive 2011/65/EC on the Restriction of Hazardous Substances, commonly known as EU-RoHS 6 and 10. All products supplied by Mercury shall be compliant with the European Directive 2011/65/EC based on the following substance list.

Substance List	Allowable Maximum Concentration
Lead (Pb)	<1000 PPM (0.1% by weight)
Mercury (Hg)	<1000 PPM (0.1% by weight)
Cadmium (Cd)	<75 PPM (0.0075% by weight)
Hexavalent Chromium (CrVI)	<1000 PPM (0.1% by weight)
Polybrominated Biphenyls (PBB)	<1000 PPM (0.1% by weight)
Polybrominated Diphenyl ethers (PBDE)	<1000 PPM (0.1% by weight)
Decabromodiphenyl Deca BDE	<1000 PPM (0.1% by weight)
Bis (2-ethylhexyl) Phthalate (DEHP)	<1000 PPM (0.1% by weight)
Butyl Benzyl Phthalate (BBP)	<1000 PPM (0.1% by weight)
Dibutyl Phthalate (DBP)	<1000 PPM (0.1% by weight)
Diisobutyl Phthalate (DIBP)	<1000 PPM (0.1% by weight)

**REACH:** Mercury Systems, Inc. neither uses nor intentionally adds any of the substances considered to be a Substance of Very High Concern (SVHC) as defined by the EU Regulation (EC) No. 1907-2006 on Registration, Evaluation, Authorization, and Restriction of Chemicals (REACH).

**Conflict Materials:** Mercury does not knowingly use materials that are sourced from the Democratic Republic of Congo (DRC) or any other known conflict regions. Mercury’s supply chain is comprised of sources that are both environmentally and socially responsible. We periodically review this requirement with our vendors to ensure continued compliance.

**Mercury takes its responsibility as a global partner seriously and will use due diligence within our supply chain to ensure all standards are met to the best of our knowledge.**



**Corporate Headquarters**

50 Minuteman Road  
 Andover, MA 01810 USA  
 +1 978.967.1401 tel  
 +1 866.627.6951 tel  
 +1 978.256.3599 fax

**International Headquarters**

**Mercury International**  
 Avenue Eugène-Lance, 38  
 PO Box 584  
 CH-1212 Grand-Lancy 1  
 Geneva, Switzerland  
 +41 22 884 5100 tel

**Learn more**

**Visit:** [mrcy.com](http://mrcy.com)

For pricing details, contact: [MMICsales@mrcy.com](mailto:MMICsales@mrcy.com)

For technical details, contact: [MMICsupport@mrcy.com](mailto:MMICsupport@mrcy.com)



The Mercury Systems logo is a registered trademark of Mercury Systems, Inc. Other marks used herein may be trademarks or registered trademarks of their respective holders. Mercury products identified in this document conform with the specifications and standards described herein. Conformance to any such standards is based solely on Mercury’s internal processes and methods. The information contained in this document is subject to change at any time without notice.

