

# AM1025B – Amplifier

## 20 MHz to 3.0 GHz Gain Block

### Description

AM1025B is a high dynamic range cascadable gain block covering the 20 MHz to 3.0 GHz frequency range. The device exhibits high P1dB, high second and third order intercept performance, and low noise figure while also providing excellent gain stability over the operating temperature range. With internal 50Ω matching and packaged in a 3mm QFN or a shielded module, the AM1025B represents a compact total PCB footprint.

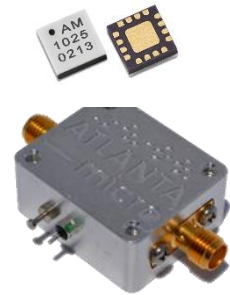

### Features

- 13.5 dB Gain
- +70 dBm OIP2
- +40 dBm OIP3
- +26 dBm P1dB
- +27 dBm PSat
- 3.8 dB Noise Figure
- +5.0V to +8.0V Supply Range
- 3mm QFN Package
- -40C to +85C Operation
- Unconditionally Stable

### Functional Diagram

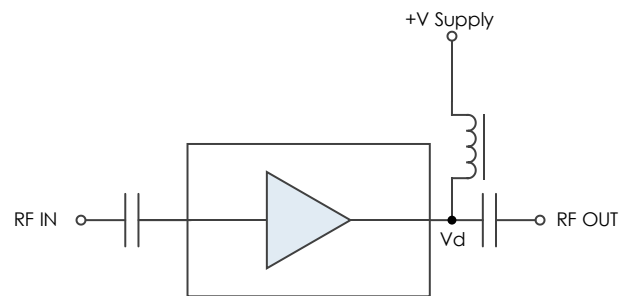

### Characteristic Performance

(V Supply = +8.0V, Device Voltage [Vd] = +7.5V, Id = 156 mA)

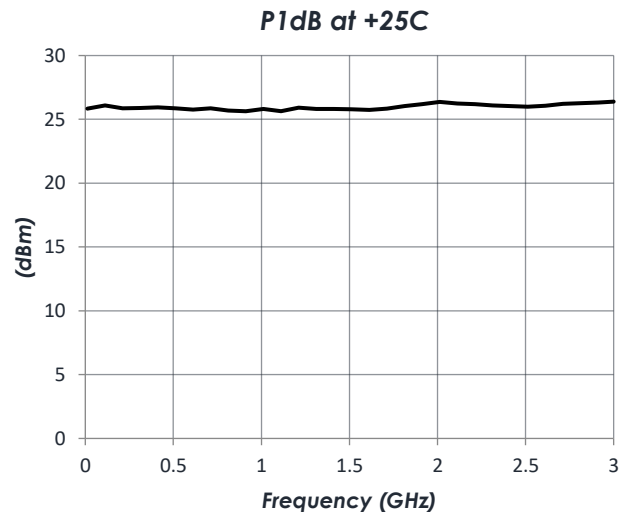
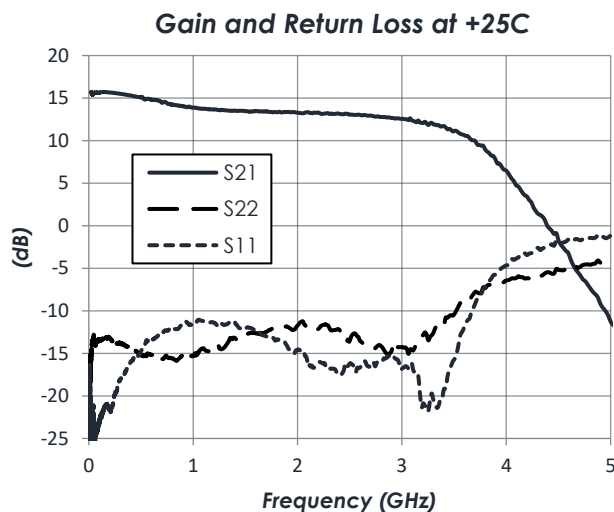

### Table of Contents

<b>Description</b> .....	1	Thermal Information .....	4
<b>Features</b> .....	1	DC Electrical Characteristics .....	5
<b>Functional Diagram</b> .....	1	RF Performance .....	5
<b>Characteristic Performance</b> .....	1	Typical Performance .....	6
<b>Revision History</b> .....	2	<b>Typical Application</b> .....	9
<b>Pin Layout and Definitions</b> .....	3	<b>Part Ordering Details</b> .....	9
<b>Specifications</b> .....	4	<b>Evaluation PC Board</b> .....	10
Absolute Maximum Ratings .....	4	<b>Related Parts</b> .....	10
Handling Information .....	4	<b>Component Compliance Information</b> .....	11
Recommended Operating Conditions .....	4		

### Revision History

Date	Revision Number	Notes
November 28, 2018	0	Preliminary Release.
November 30, 2018	0A	Recommended Ferrite Bead Changed, Extra Notes Added in Typical Application.
December 7, 2018	0B	Noise Figure vs VDD Added.
December 10, 2018	1	Initial Release.
January 21, 2019	2	Performance Plots Updated. Recommended Operating Conditions Modified.
May 13, 2019	3	Various Plots Updated.
June 6, 2019	3A	Component Compliance Information Updated
November 25, 2019	4	RF-Shielded Module Information Added, Part Ordering Details Added
May 15, 2020	5	Package and module information moved to main product page

### Pin Layout and Definitions

**NOTE:** All Non-Named Pins Are NC or GND

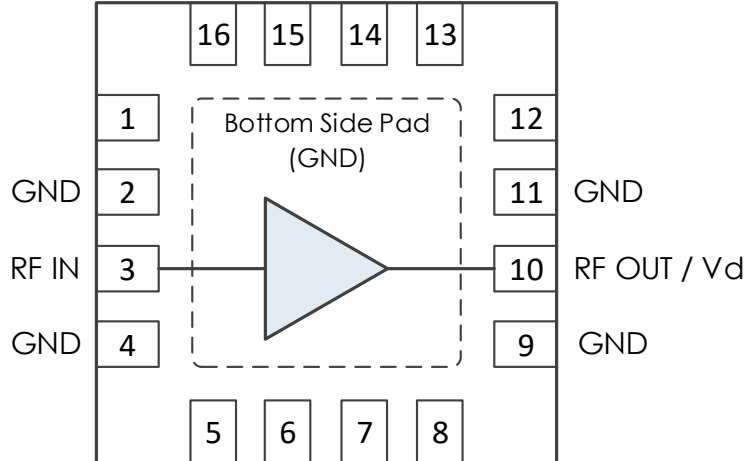

Pin Number	Pin Name	Pin Function
1	NC	Not Connected*
2	GND	Ground – Common
3	RF In	RF Input – 50 Ohms – DC Coupled, External DC Block Required
4	GND	Ground – Common
5 – 8	NC	Not Connected*
9	GND	Ground – Common
10	RF Out/ Vd	RF Output and DC Power Input – 50 Ohms – DC Coupled, External DC Block Required
11	GND	Ground – Common
12 – 16	NC	Not Connected*
Bottom Pad	GND	Ground – Common

\*Note: NC pins may be grounded or left open.

# AM1025B – Amplifier

## 20 MHz to 3.0 GHz Gain Block



### Specifications

#### Absolute Maximum Ratings

	Minimum	Maximum
Supply Voltage	-0.3 V	+10.0 V
RF Input Power		+20 dBm
Operating Junction Temperature	-40 C	+150 C
Storage Temperature Range	-50 C	+150 C

**Note:** Any device operation beyond the Absolute Maximum Ratings may result in permanent damage to the device. The values listed in this table are extremes and do not imply functional operation of the device at these or any other conditions beyond what is listed under Recommended Operating Conditions. Any part subjected to conditions outside of what is recommended for an extended amount of time may suffer from reliability concerns.

#### Handling Information

	Minimum	Maximum
Storage Temperature Range (Recommended)	-50 C	+125 C
Moisture Sensitivity Level	MSL 3	



Atlanta Micro products are electrostatic sensitive.  
Follow safe handling practices to avoid damage

#### Recommended Operating Conditions

	Minimum	Typical	Maximum
Supply Voltage	+5.0 V	+8.0 V	+8.0 V
Device Voltage	+4.7 V	+7.5 V	+8.0 V
Operating Case Temperature	-40 C		+85 C
Operating Junction Temperature	-40 C		+145 C

#### Thermal Information

	Thermal Resistance (°C / W)
Junction to Case Thermal Resistance ( $\theta_{JC}$ )	51.6

# AM1025B – Amplifier

## 20 MHz to 3.0 GHz Gain Block

### DC Electrical Characteristics

(T = 25 °C unless otherwise specified)

Parameter	Testing Conditions	Minimum	Typical	Maximum
DC Supply Voltage		+5.0 V	+8.0 V	+8.0 V
DC Device Voltage (Vd)		+4.7 V	+7.5 V	+8.0 V
DC Device Current	V Supply = +5.0 V		70 mA	
	V Supply = +8.0 V		156 mA	
Power Dissipated By IC	V Supply = +5.0 V		350 mW	
	V Supply = +8.0 V		1.17 W	

### RF Performance

(T = 25 °C unless otherwise specified)

Parameter	Testing Conditions	Minimum	Typical	Maximum
Frequency Range		20 MHz		3.0 GHz
Gain	V Supply = +8.0 V		13.5 dB	
Return Loss	V Supply = +8.0 V		14 dB	
Reverse Isolation	V Supply = +8.0 V		22 dB	
Output IP3	V Supply = +8.0 V		+40 dBm	
Output IP2	V Supply = +8.0 V		+70 dBm	
Output P1dB	V Supply = +8.0 V		+26 dBm	
Output Power Saturation	V Supply = +8.0 V		+27 dBm	
Noise Figure	V Supply = +8.0 V		3.8 dB	

# AM1025B – Amplifier

## 20 MHz to 3.0 GHz Gain Block

### Typical Performance

(V Supply = +8.0V, Device Voltage [Vd] = +7.5V, Id = 156 mA)

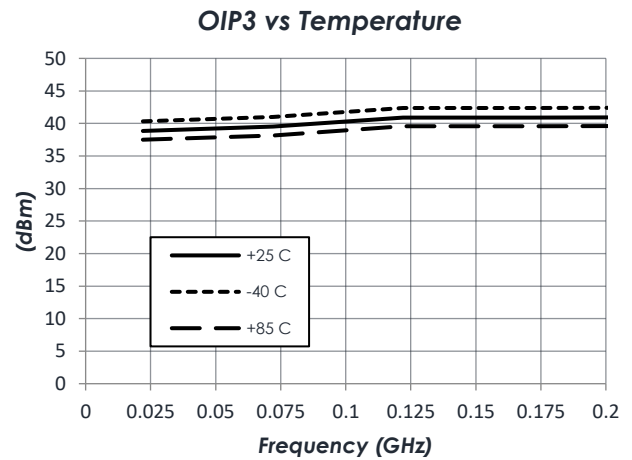
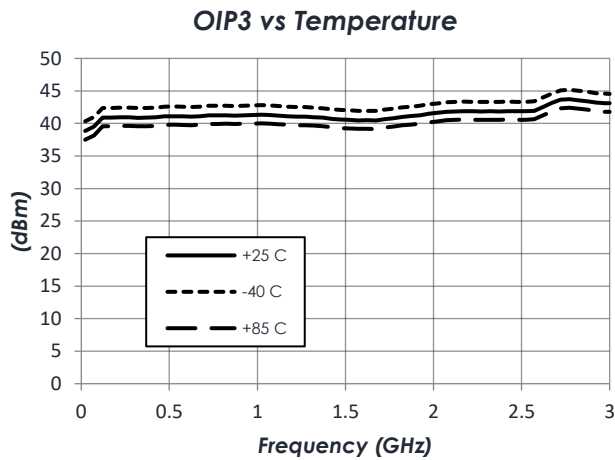
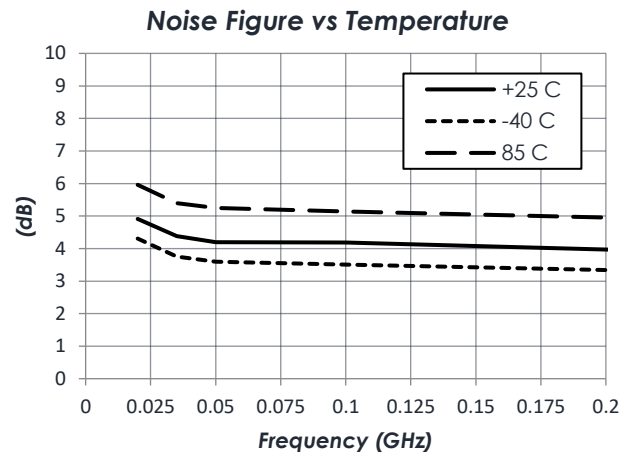
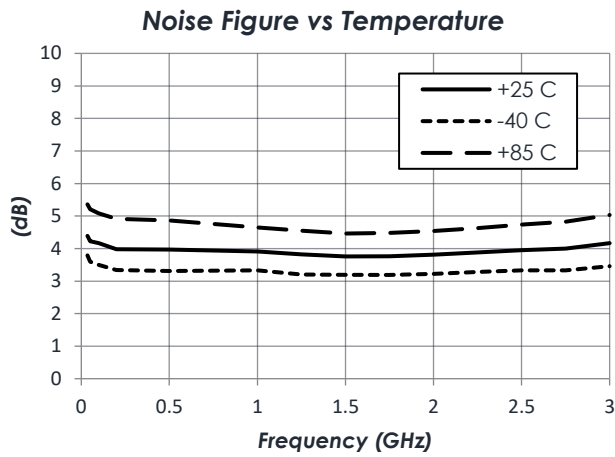
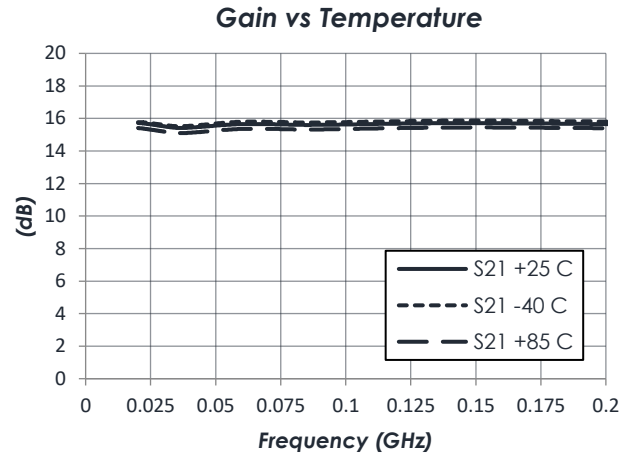
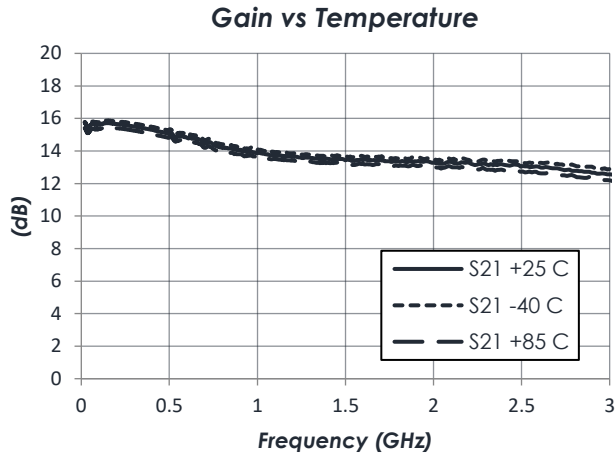

# AM1025B – Amplifier

## 20 MHz to 3.0 GHz Gain Block

### Typical Performance (continued)

(V Supply = +8.0V, Device Voltage [Vd] = +7.5V, Id = 156 mA)

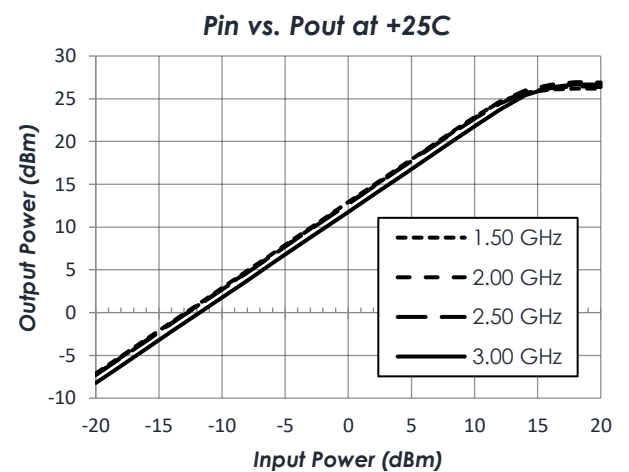
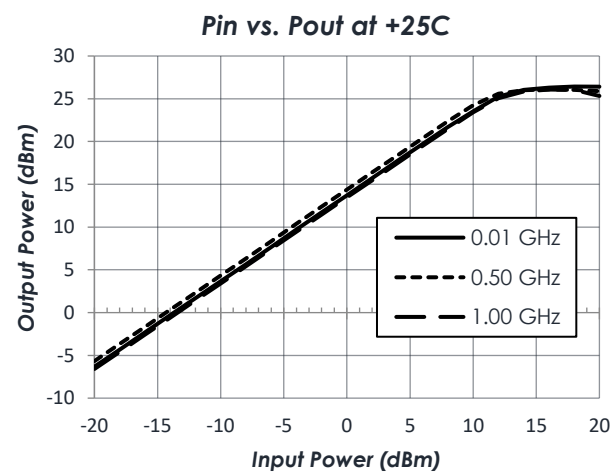
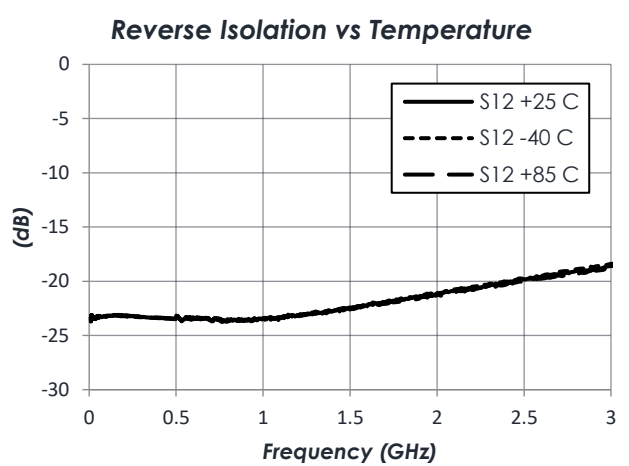
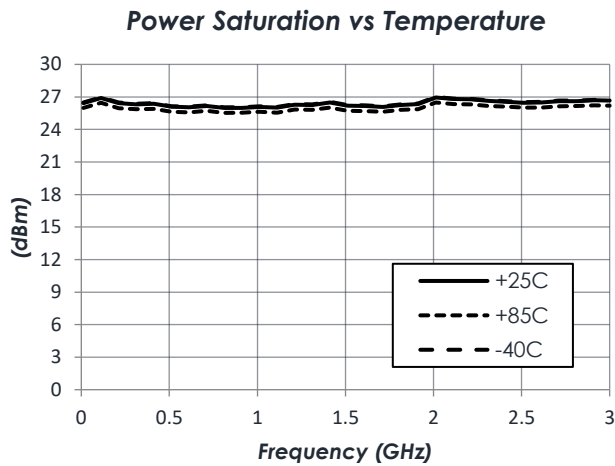
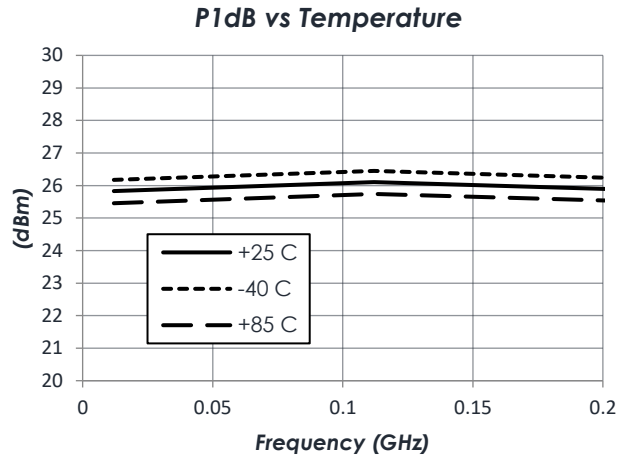
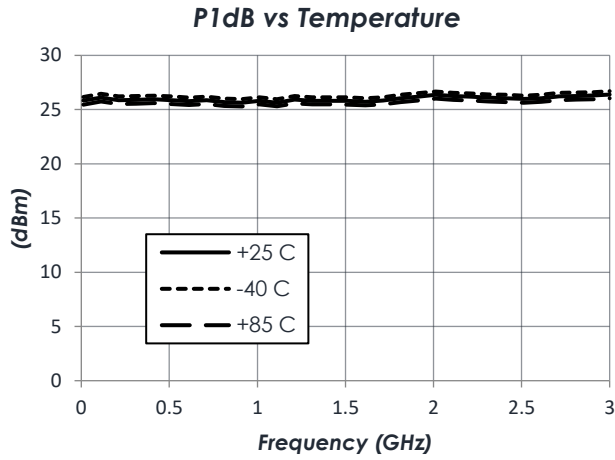

# AM1025B – Amplifier

## 20 MHz to 3.0 GHz Gain Block

### Typical Performance (continued)

(T = 25°C Unless Otherwise Specified)

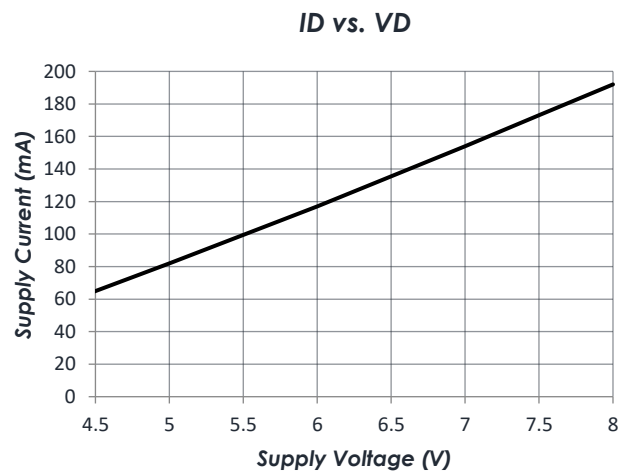
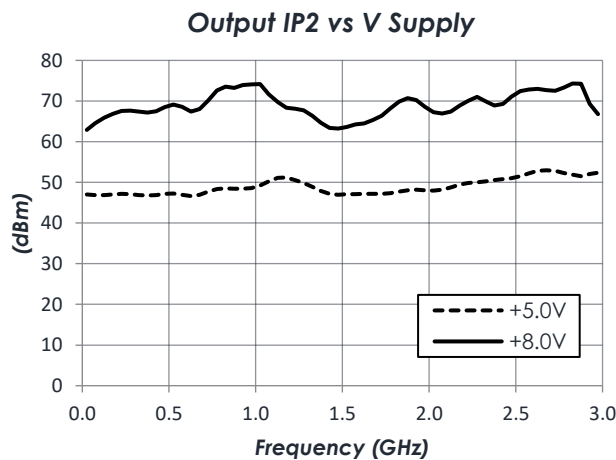
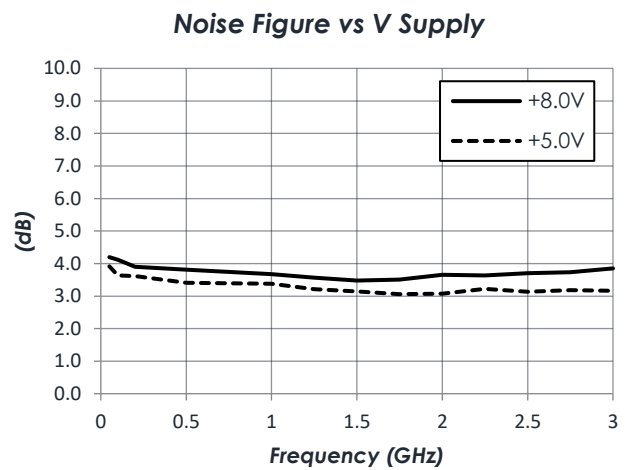
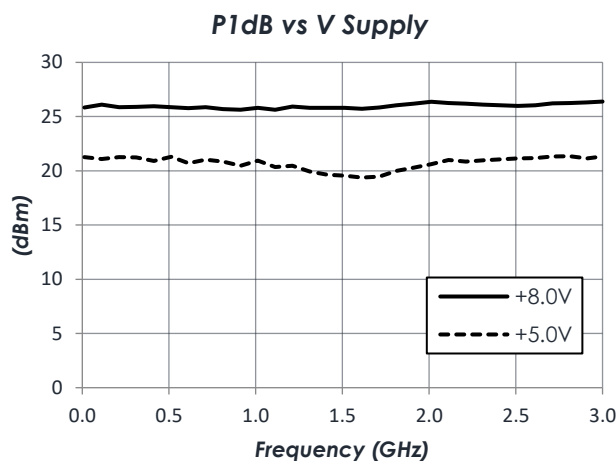
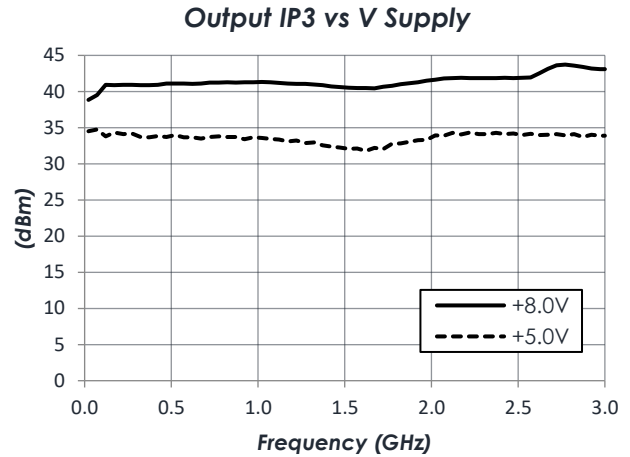
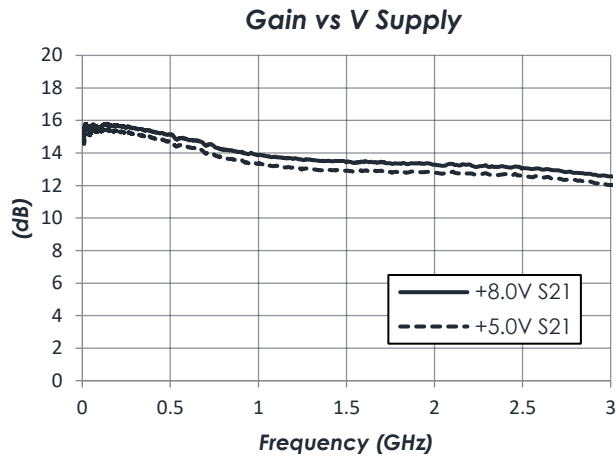



# AM1025B – Amplifier

## 20 MHz to 3.0 GHz Gain Block

### Typical Application

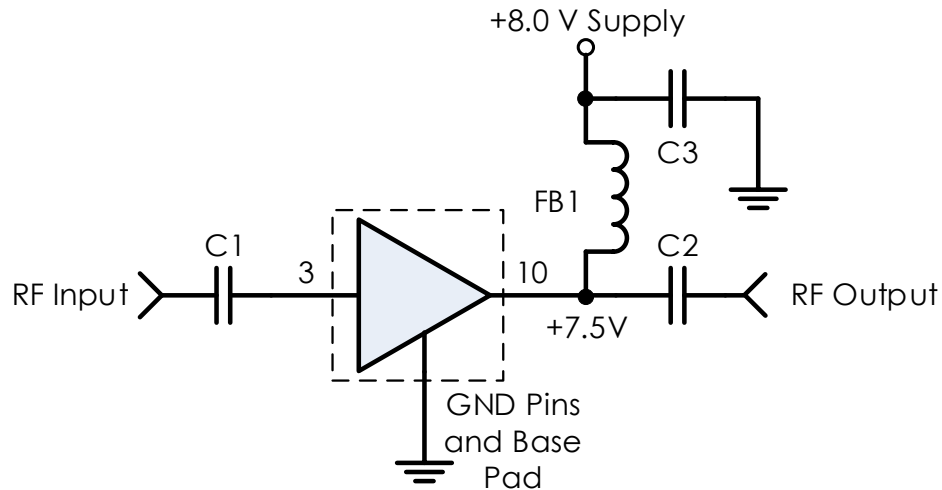

### Recommended Component List (or equivalent):

Part	Value	Part Number	Manufacturer
C1, C2	0.1 $\mu$ F	0402BB104KW160	Passives Plus
C3	0.1 $\mu$ F	GRM155R71C104KA88	Murata
FB1	-	BLM15HG102SN1D	Murata

### Notes:

1. NC pins may be grounded or left open.
2. External DC blocking capacitors and RF choke are required.
  - a. RF blocking capacitors should be high performance, low-loss, broadband capacitors for optimum performance.
  - b. Select values for the frequency range of interest.
3. No input or output matching is required.

### Part Ordering Details

Description	Part Number
3mm 16 Lead QFN	AM1025B
AM1025B Evaluation Board	AM1025B Eval
AM1025B in 0.95" x 1.13" x 0.6" RF-Shielded Module with Integrated Bias Tee and Field Replaceable SMA Connectors	AM1025B-M

# AM1025B – Amplifier

## 20 MHz to 3.0 GHz Gain Block

### Evaluation PC Board

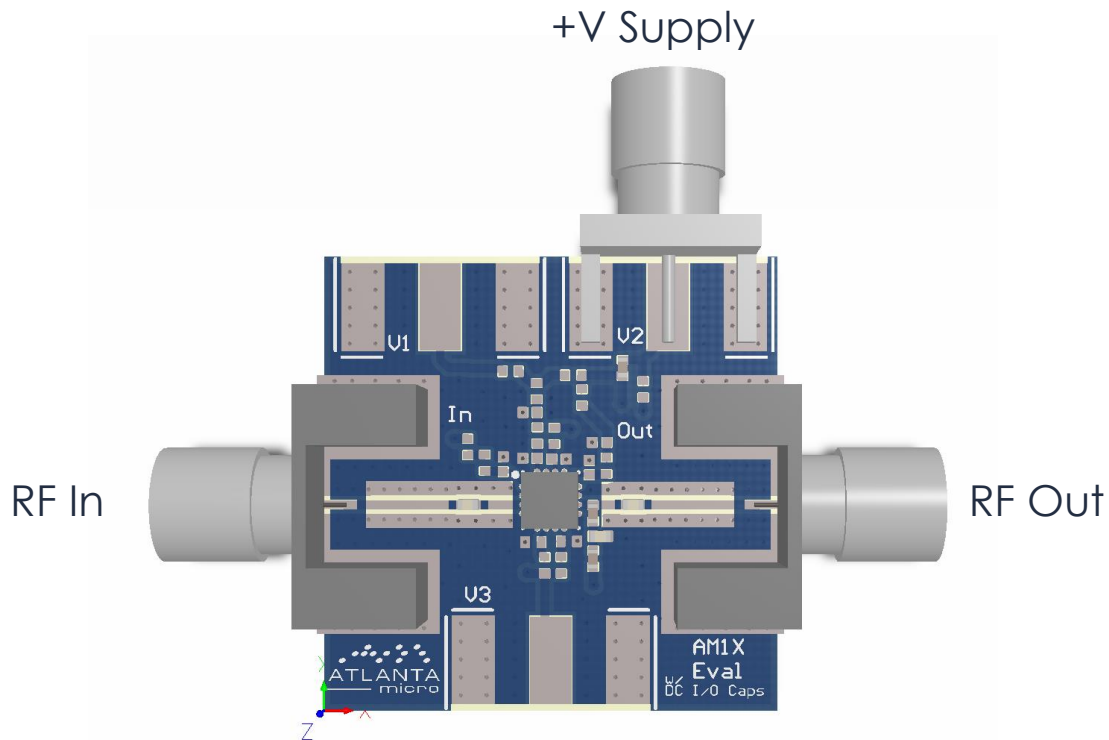

### Related Parts

Part Number	Description		
AM1016B	20 MHz	to 6 GHz	+3.3V Gain Block
AM1018B	20 MHz	to 6 GHz	+5.0V Gain Block
AM1018C	20 MHz	to 6 GHz	+5.0V Gain Block
AM1031C	20 MHz	to 8 GHz	+3.3V Gain Block
AM1063-1	DC	to 10 GHz	Gain Block
AM1063-2	DC	to 10 GHz	Miniature Gain Block
AM1064-1	DC	to 8 GHz	Gain Block
AM1064-2	DC	to 8 GHz	Miniature Gain Block

## Component Compliance Information

**RoHS:** Atlanta Micro, Inc. hereby certifies that all products comply with the EC Directive 2011/65/EC on the Restriction of Hazardous Substances, commonly known as EU-RoHS 6 and 10. All products supplied by Atlanta Micro shall be compliant with the European Directive 2011/65/EC based on the following substance list.

Substance List	Allowable Maximum Concentration
Lead (Pb)	<1000 PPM (0.1% by weight)
Mercury (Hg)	<1000 PPM (0.1% by weight)
Cadmium (Cd)	<75 PPM (0.0075% by weight)
Hexavalent Chromium (CrVI)	<1000 PPM (0.1% by weight)
Polybrominated Biphenyls (PBB)	<1000 PPM (0.1% by weight)
Polybrominated Diphenyl ethers (PBDE)	<1000 PPM (0.1% by weight)
Decabromodiphenyl Deca BDE	<1000 PPM (0.1% by weight)
Bis (2-ethylhexyl) Phthalate (DEHP)	<1000 PPM (0.1% by weight)
Butyl Benzyl Phthalate (BBP)	<1000 PPM (0.1% by weight)
Dibutyl Phthalate (DBP)	<1000 PPM (0.1% by weight)
Diisobutyl Phthalate (DIBP)	<1000 PPM (0.1% by weight)

**REACH:** Atlanta Micro, Inc. neither uses nor intentionally adds any of the substances considered to be a Substance of Very High Concern (SVHC) as defined by the EU Regulation (EC) No. 1907-2006 on Registration, Evaluation, Authorization, and Restriction of Chemicals (REACH).

**Conflict Materials:** Atlanta Micro does not knowingly use materials that are sourced from the Democratic Republic of Congo (DRC) or any other known conflict regions. Atlanta Micro's supply chain is comprised of sources that are both environmentally and socially responsible. We periodically review this requirement with our vendors to ensure continued compliance.

Atlanta Micro takes its responsibility as a global partner seriously and will use due diligence within our supply chain to ensure all standards are met to the best of our knowledge.