

# AM1077 – Bypassable Amplifier

## 5 GHz to 20 GHz Gain Block w/ Isolation State

### Description

The AM1077 is a high dynamic range amplifier covering the 5 GHz to 20 GHz frequency range offering both a bypass mode and an isolation mode. The device provides high gain with low bypass insertion loss and is capable of producing a +16 dBm output power with a single +3.3V supply. With internal 50Ω matching and packaged in a 4mm QFN, the AM1077 represents a dramatic size reduction over a discrete implementation of a bypassable amplifier with an isolation state. The AM1077 is the AM1067 with an isolation state added.

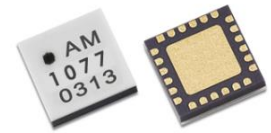

### Features

- 20 dB Gain
- 4.0 dB Noise Figure
- +25 dBm OIP3
- +14 dBm P1dB
- +3.3V, 85 mA TYP
- +3.3V or +5V Logic Compatible
- 2.0 dB TYP Insertion Loss in Bypass
- 50 dB TYP Insertion Loss in Isolation
- -40C to +85C Operation
- 4mm QFN Package

### Functional Diagram

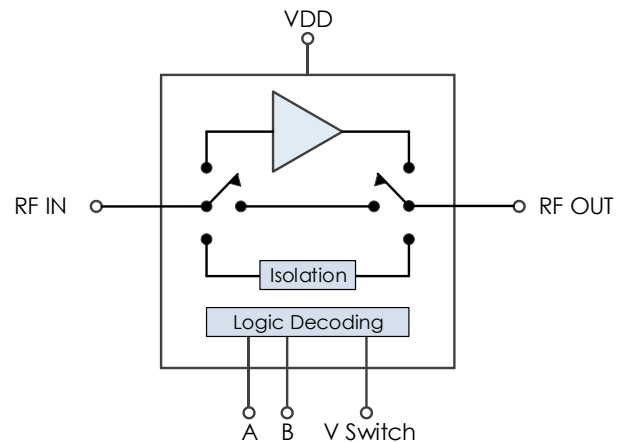

### Characteristic Performance

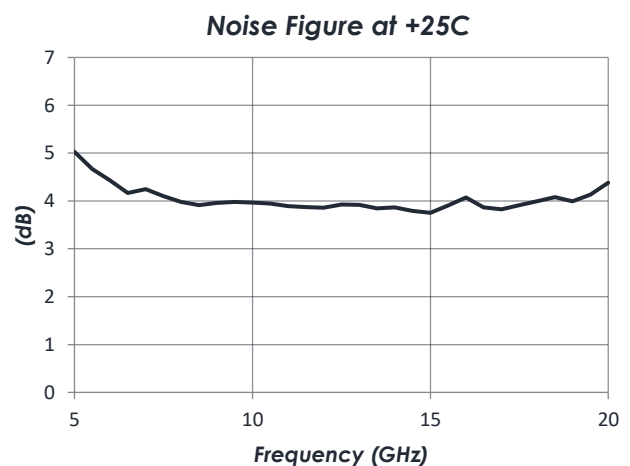
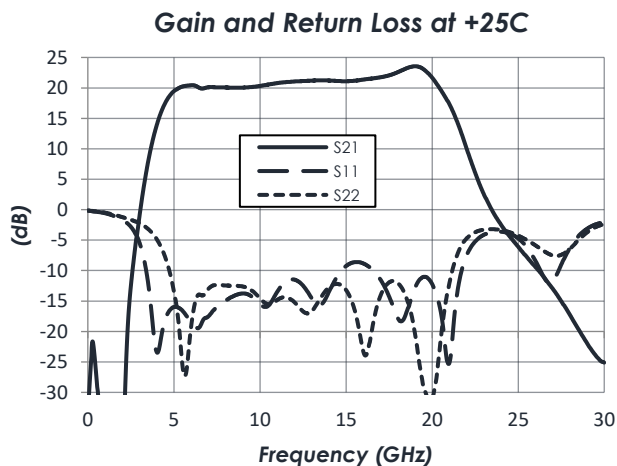

## Table of Contents

<b>Description</b> .....	1	DC Electrical Characteristics .....	5
<b>Features</b> .....	1	RF Performance .....	5
<b>Functional Diagram</b> .....	1	Timing Characteristics .....	5
<b>Characteristic Performance</b> .....	1	State Table .....	5
<b>Revision History</b> .....	2	Typical Performance .....	6
<b>Pin Layout and Definitions</b> .....	3	<b>Typical Application</b> .....	8
<b>Specifications</b> .....	4	<b>Package Details</b> .....	10
Absolute Maximum Ratings .....	4	<b>Evaluation PC Board</b> .....	11
Handling Information .....	4	<b>Related Parts</b> .....	11
Recommended Operating Conditions .....	4	<b>Component Compliance Information</b> ...	Error!
Thermal Information .....	4	Bookmark not defined.	

## Revision History

Date	Revision Number	Notes
August 13, 2018	1	Initial Release
January 14, 2020	2	Logic Table Corrected

# AM1077 – Bypassable Amplifier

## 5 GHz to 20 GHz Gain Block w/ Isolation State



### Pin Layout and Definitions

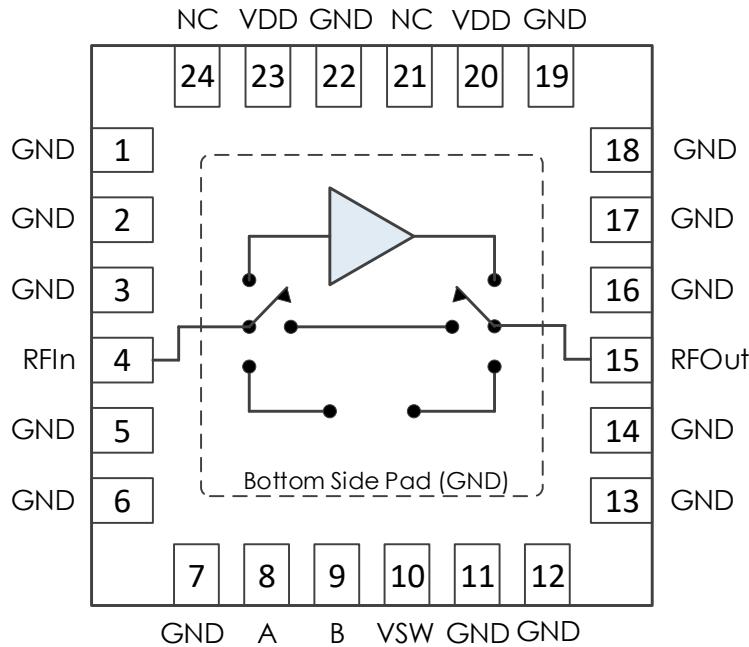

Pin Number	Pin Name	Pin Function
1-3	GND	Ground - Common
4	RF In	RF Input – 50 Ohms – DC Coupled. External DC Blocking Capacitor Required*
5-7	GND	Ground - Common
8	A	Control Bit A
9	B	Control Bit B
10	VSW	DC Switch Power Input
11-14	GND	Ground - Common
15	RF Out	RF Output – 50 Ohms – DC Coupled. External DC Blocking Capacitor Required*
16-19	GND	Ground - Common
20	VDD	DC Power Input
21	NC	Do Not Connect
22	GND	Ground - Common
23	VDD	DC Power Input
24	NC	Do Not Connect
Case GND	GND	Ground - Common

**\*Note:** DC blocking caps not required if in series with other Atlanta Micro parts of the same reference voltage.

# AM1077 – Bypassable Amplifier

## 5 GHz to 20 GHz Gain Block w/ Isolation State

### Specifications

#### Absolute Maximum Ratings

	Minimum	Maximum
Supply Voltage	-0.3 V	+3.7 V
RF Input Power		+20 dBm
Operating Junction Temperature	-40 C	+150 C
Storage Temperature Range	-50 C	+150 C

**Note:** Any device operation beyond the Absolute Maximum Ratings may result in permanent damage to the device. The values listed in this table are extremes and do not imply functional operation of the device at these or any other conditions beyond what is listed under Recommended Operating Conditions. Any part subjected to conditions outside of what is recommended for an extended amount of time may suffer from reliability concerns.

#### Handling Information

	Minimum	Maximum
Storage Temperature Range (Recommended)	-50 C	+125 C
Moisture Sensitivity Level	MSL 1	



Atlanta Micro products are electrostatic sensitive.  
Follow safe handling practices to avoid damage

#### Recommended Operating Conditions

	Minimum	Typical	Maximum
Supply Voltage	+2.7 V	+3.3 V	+3.5 V
Operating Case Temperature	-40 C		+85 C
Operating Junction Temperature	-40 C		+133 C

#### Thermal Information

	Thermal Resistance (°C / W)
Junction to Case Thermal Resistance ( $\theta_{JC}$ )	172

# AM1077 – Bypassable Amplifier

## 5 GHz to 20 GHz Gain Block w/ Isolation State

### DC Electrical Characteristics

(T = 25 °C unless otherwise specified)

Parameter	Testing Conditions	Minimum	Typical	Maximum
DC Supply Voltage			+3.3V	
DC Supply Current	VDD = +3.3 V		85 mA	
Power Dissipated	VDD = +3.3 V		0.28 W	
DC Switch Voltage		+2.5 V	+VDD	+6.0 V
DC Switch Current			1 mA	
Logic Level Low		0.0 V		+0.5 V
Logic Level High		+2.0 V		+V Switch

### RF Performance

(T = 25 °C, VDD = +3.3 V unless otherwise specified)

Parameter	Testing Conditions	Minimum	Typical	Maximum
Frequency Range		5.0 GHz		20.0 GHz
Gain	f = 5 GHz		19.5 dB	
	f = 12.5 GHz		21.2 dB	
	f = 20 GHz		21.3 dB	
Return Loss	f = 5 GHz		20.0 dB	
	f = 12.5 GHz		16.7 dB	
	f = 20 GHz		28.4 dB	
Output IP3			+25 dBm	
Output P1dB			+14 dBm	
Noise Figure			4.0 dB	
Bypass Insertion Loss			2.0 dB	
Isolation Insertion Loss			50 dB	

### Timing Characteristics

Parameter	Minimum	Typical	Maximum
Turn On Time			3.5 $\mu$ s
Turn Off Time			20.0 $\mu$ s
Switching Speed (Amp Bypass $\rightarrow$ Amp On)			3.8 $\mu$ s
Switching Speed (Amp On $\rightarrow$ Amp Bypass)			21.0 $\mu$ s

### State Table

B	A	State
Low	Low	Isolation State
Low	High	Amplifier Bypass
High	Low	Amplifier On
High	High	Do Not Use

# AM1077 – Bypassable Amplifier

## 5 GHz to 20 GHz Gain Block w/ Isolation State

### Typical Performance

(Amplifier Enabled, VDD = +3.3 V, ID = 85mA)

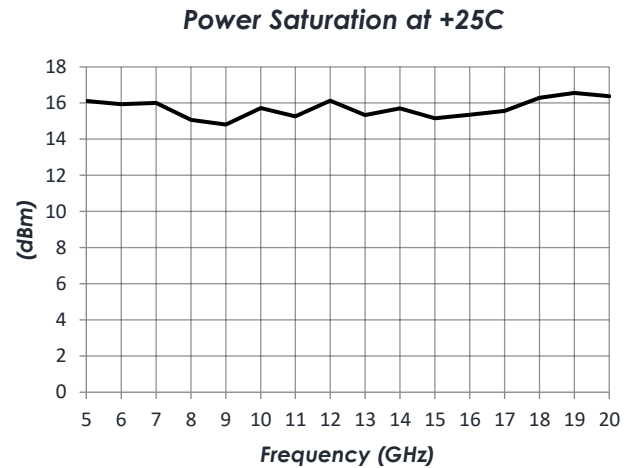
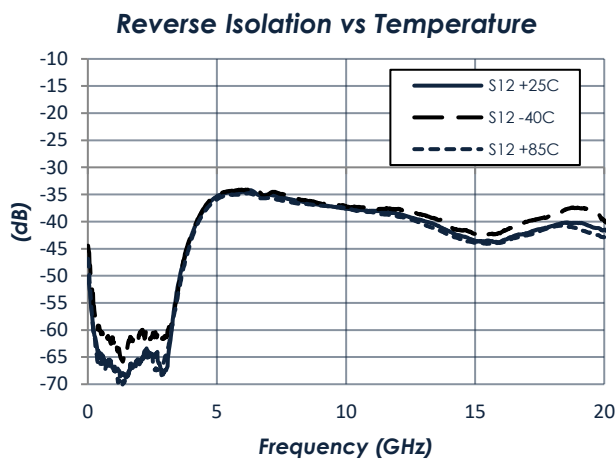
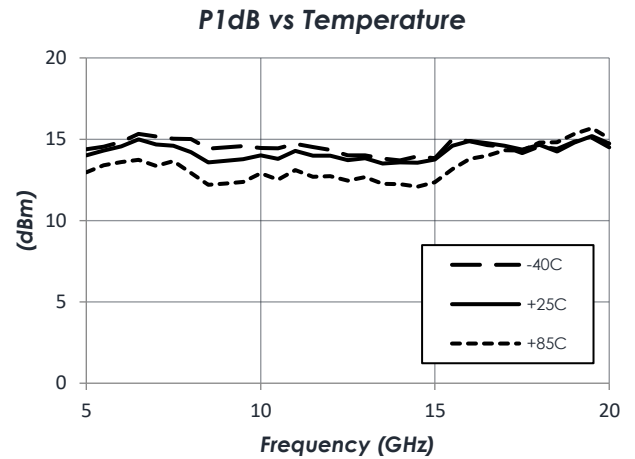
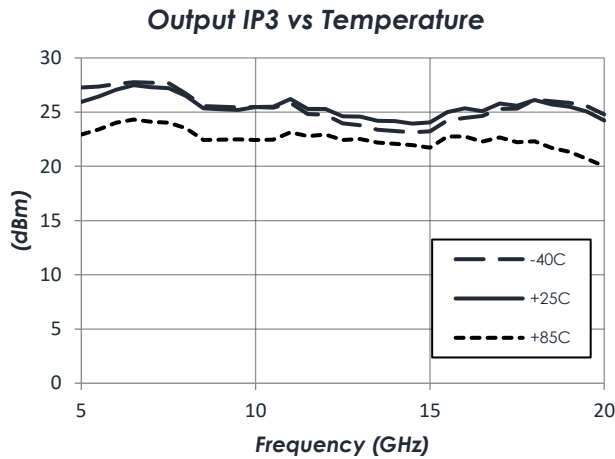
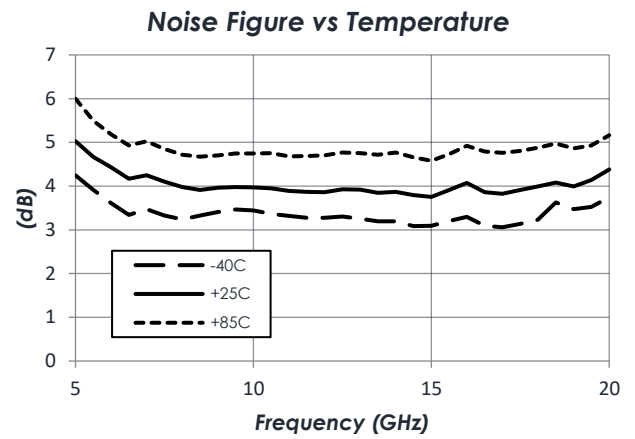
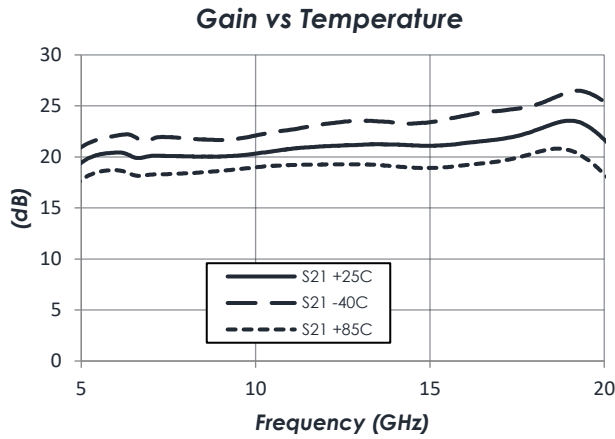

# AM1077 – Bypassable Amplifier

## 5 GHz to 20 GHz Gain Block w/ Isolation State

### Typical Performance (continued)

(Amplifier Enabled, VDD = +3.3 V, ID = 85mA)

Pin vs. Pout at +25C

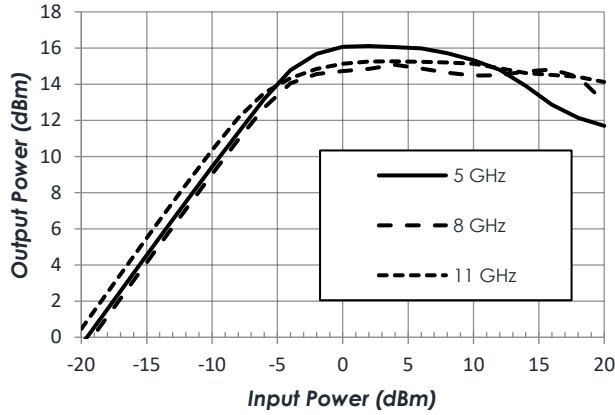

Pin vs. Pout at +25C

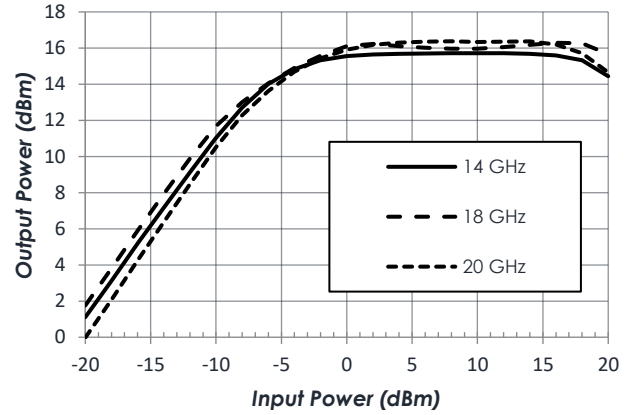

Output IP3 vs VDD

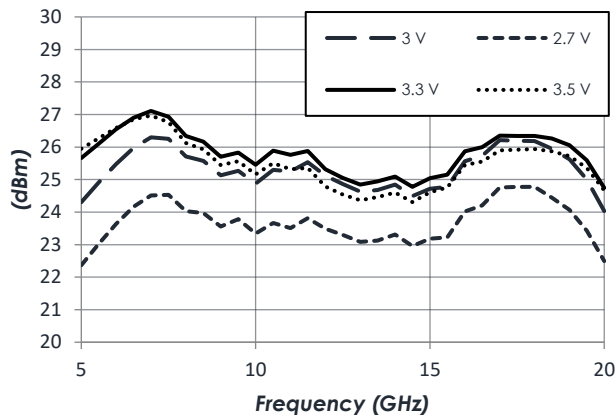

P1dB vs VDD

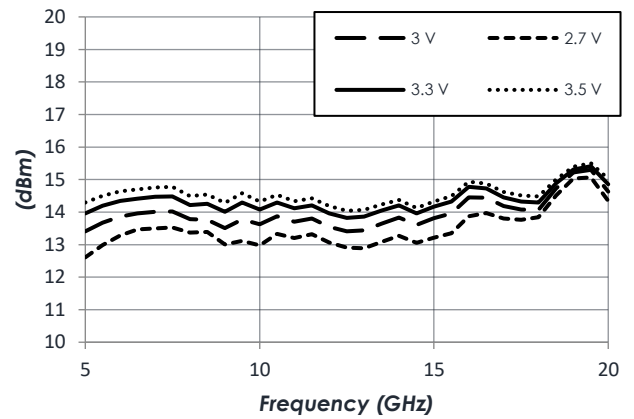

ID vs. VDD

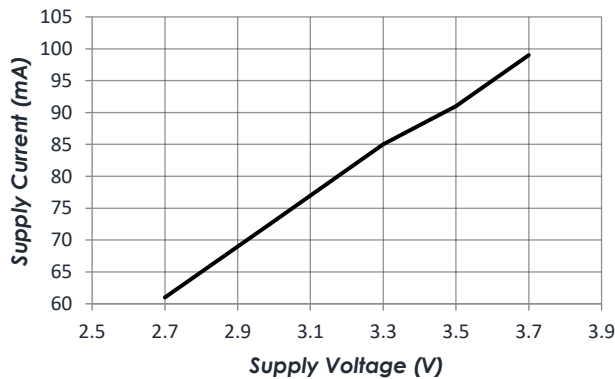

# AM1077 – Bypassable Amplifier

## 5 GHz to 20 GHz Gain Block w/ Isolation State

### Typical Performance (continued)

(Amplifier Bypassed, VDD = +3.3 V, ID = 0mA)

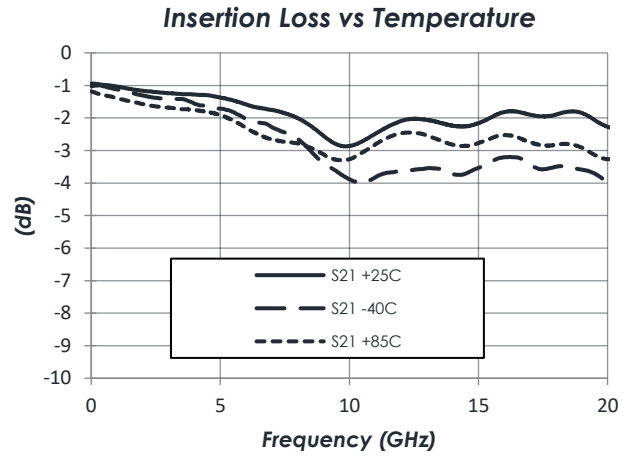
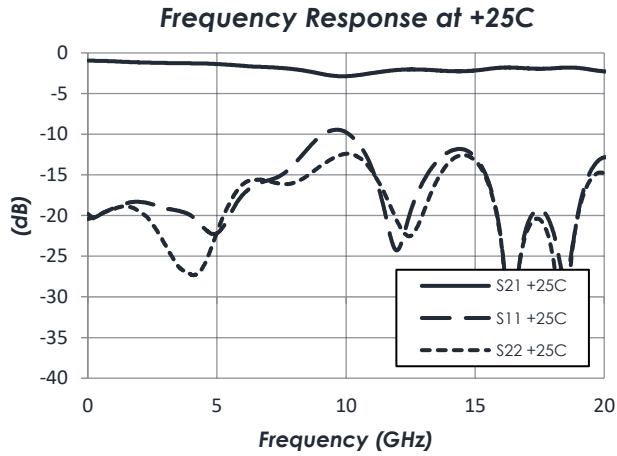

(Isolation Enabled, VDD = +3.3 V, ID = 0mA)

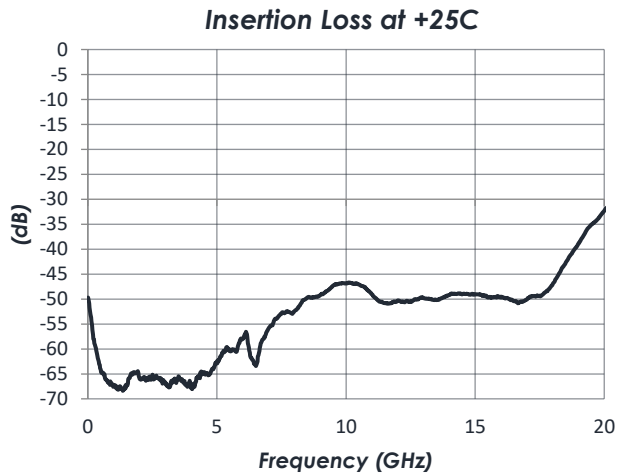



# AM1077 – Bypassable Amplifier

## 5 GHz to 20 GHz Gain Block w/ Isolation State

### Typical Application

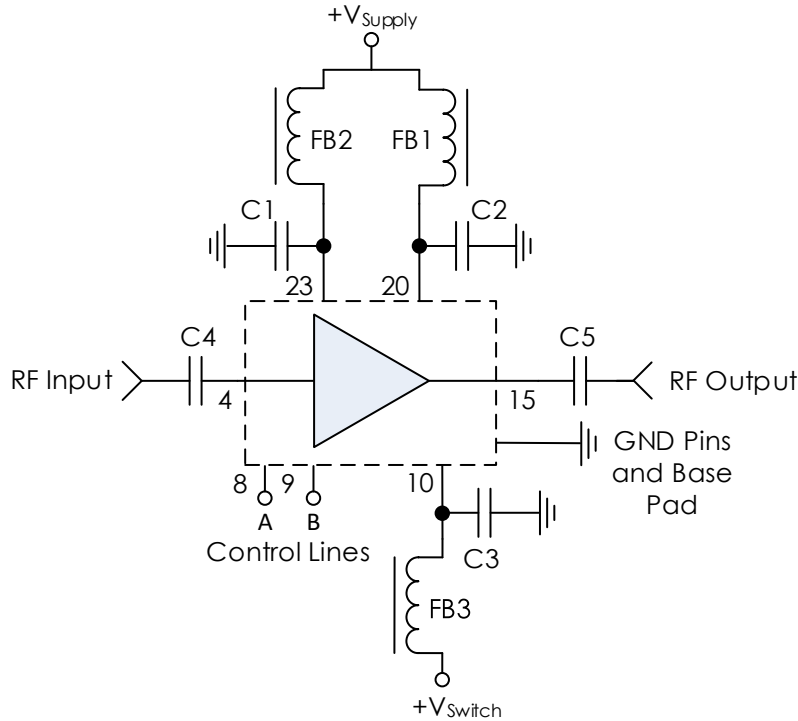

### Recommended Component List (or equivalent):

Part	Value	Part Number	Manufacturer
FB1 – FB3	-	MMZ1005A222E	TDK
C1 – C3	0.1µF	C1005X7R1H104K050BB	TDK
C4, C5	0.1µF	0201BB104KW160	Passives Plus

### Notes:

1. RF blocking capacitors should be high performance, low-loss, broadband capacitors for optimum performance.
2. RC filtering on control lines is recommended to prevent digital noise from coupling to RF path.
  - a. Select control line RC filter values based on desired logic source decoupling and switching speed.

# AM1077 – Bypassable Amplifier

## 5 GHz to 20 GHz Gain Block w/ Isolation State



### Package Details

#### Package Drawing

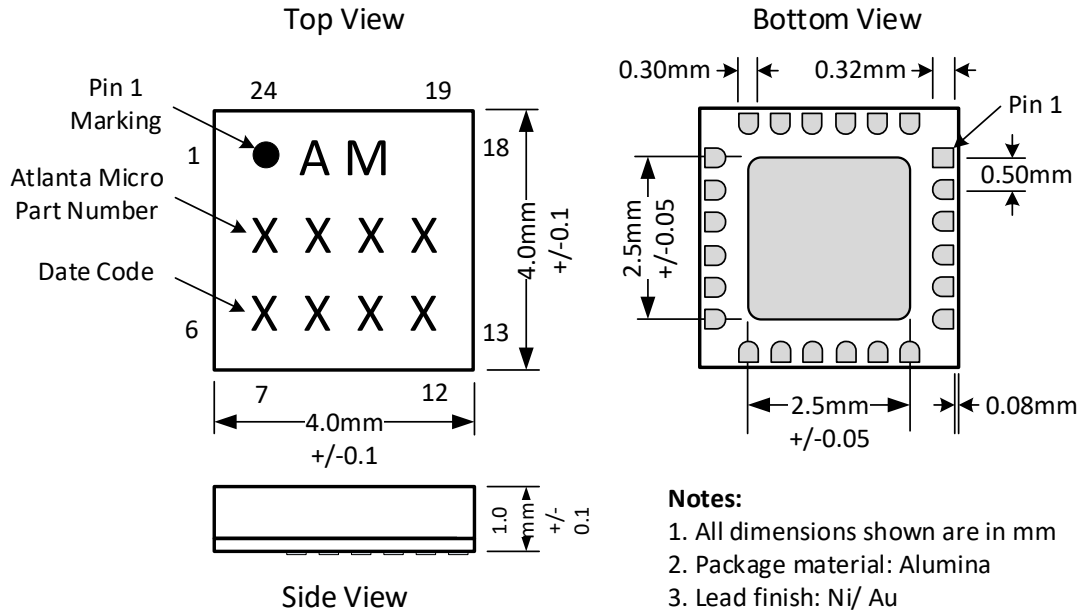

#### Recommended Footprint

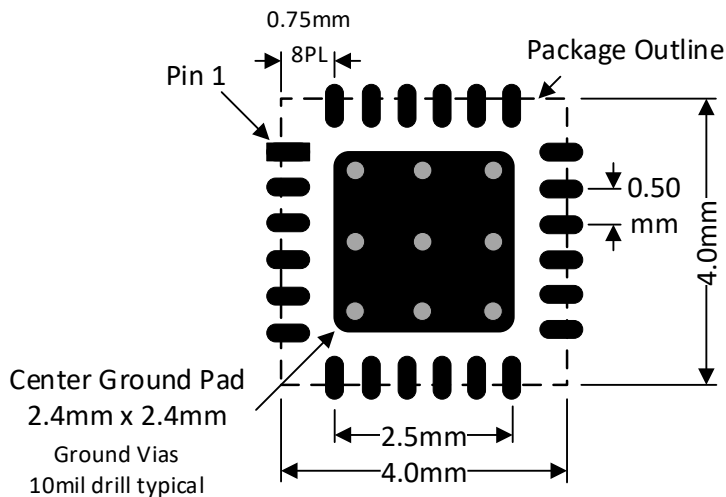

#### Pad and Spacing Detail

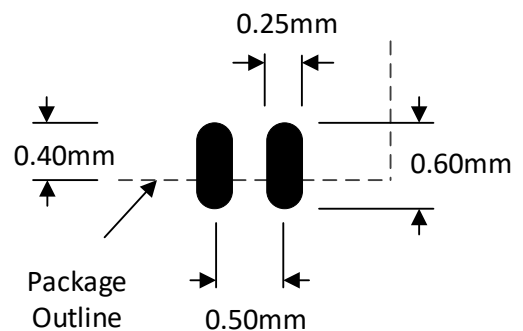

Recommend 0.08mm soldermask  
 oversize beyond pad outlines

# AM1077 – Bypassable Amplifier

## 5 GHz to 20 GHz Gain Block w/ Isolation State

### Evaluation PC Board

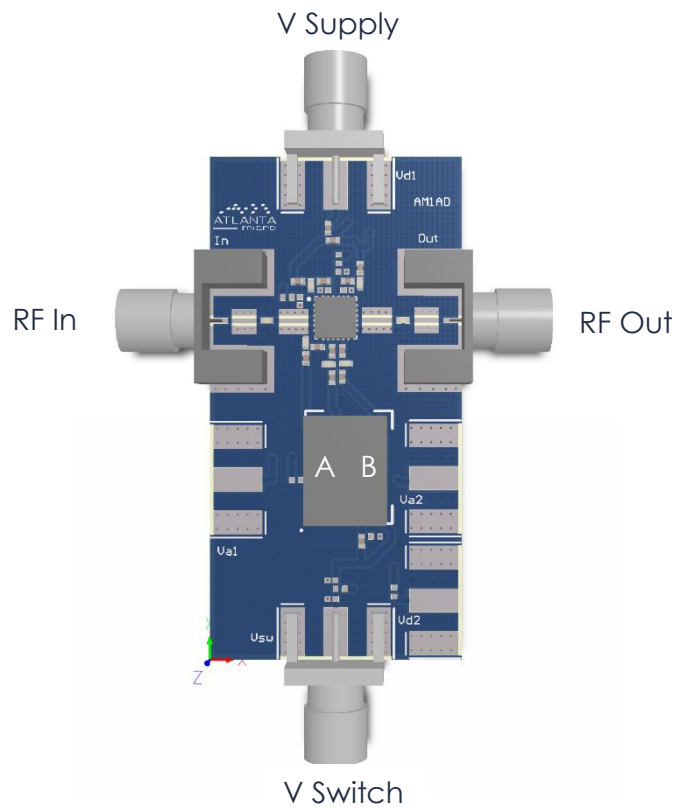

### Related Parts

Part Number	Description
AM1053	5 GHz to 20 GHz Gain Block
AM1065	DC to 8 GHz Bypassable Gain Block
<b>AM1067</b>	<b>5 GHz to 20 GHz Bypassable Gain Block</b>
AM1073	DC to 8 GHz Bi-directional Bypassable Gain Block
AM1074	6 GHz to 26.5 GHz Gain Block

# AM1077 – Bypassable Amplifier

## 5 GHz to 20 GHz Gain Block w/ Isolation State



### Component Compliance Information

**RoHS:** Atlanta Micro, Inc. hereby certifies that all products comply with the EC Directive 2011/65/EC on the Restriction of Hazardous Substances, commonly known as EU-RoHS 6 and 10. All products supplied by Atlanta Micro shall be compliant with the European Directive 2011/65/EC based on the following substance list.

Substance List	Allowable Maximum Concentration
Lead (Pb)	<1000 PPM (0.1% by weight)
Mercury (Hg)	<1000 PPM (0.1% by weight)
Cadmium (Cd)	<75 PPM (0.0075% by weight)
Hexavalent Chromium (CrVI)	<1000 PPM (0.1% by weight)
Polybrominated Biphenyls (PBB)	<1000 PPM (0.1% by weight)
Polybrominated Diphenyl ethers (PBDE)	<1000 PPM (0.1% by weight)
Decabromodiphenyl Deca BDE	<1000 PPM (0.1% by weight)
Bis (2-ethylhexyl) Phthalate (DEHP)	<1000 PPM (0.1% by weight)
Butyl Benzyl Phthalate (BBP)	<1000 PPM (0.1% by weight)
Dibutyl Phthalate (DBP)	<1000 PPM (0.1% by weight)
Diisobutyl Phthalate (DIBP)	<1000 PPM (0.1% by weight)

**REACH:** Atlanta Micro, Inc. neither uses nor intentionally adds any of the substances considered to be a Substance of Very High Concern (SVHC) as defined by the EU Regulation (EC) No. 1907-2006 on Registration, Evaluation, Authorization, and Restriction of Chemicals (REACH).

**Conflict Materials:** Atlanta Micro does not knowingly use materials that are sourced from the Democratic Republic of Congo (DRC) or any other known conflict regions. Atlanta Micro's supply chain is comprised of sources that are both environmentally and socially responsible. We periodically review this requirement with our vendors to ensure continued compliance.

Atlanta Micro takes its responsibility as a global partner seriously and will use due diligence within our supply chain to ensure all standards are met to the best of our knowledge.