

AM4001 - Splitter

2-18 GHz 2-Way 0° Splitter

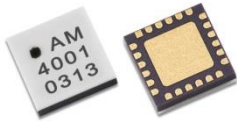

AM4001 is a two-way power splitter / combiner that provides low loss and high isolation in a small 4mm package.

Features

- 1.7 dB Insertion Loss
- 20 dB Isolation
- 10 dB Return Loss
- 4mm QFN Package
- -40 to +85C Operation

Functional Diagram

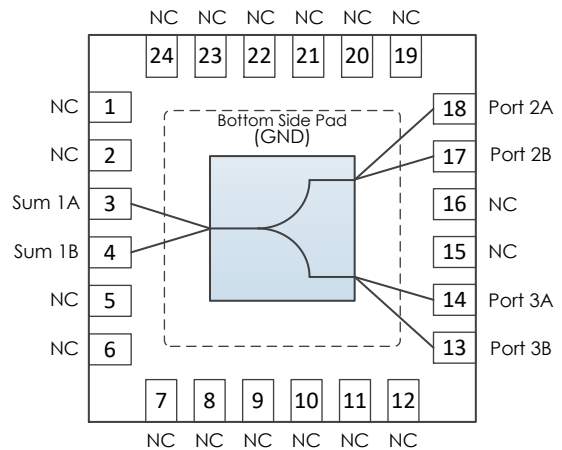

Performance

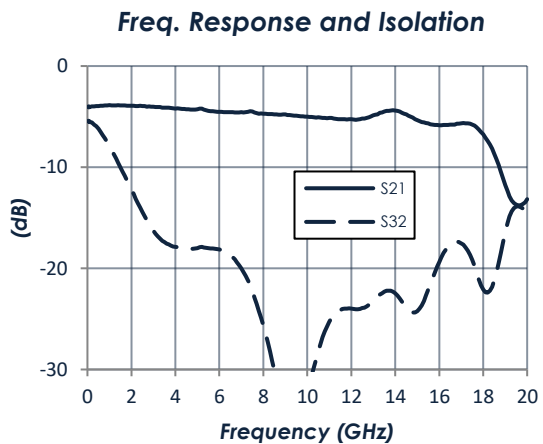
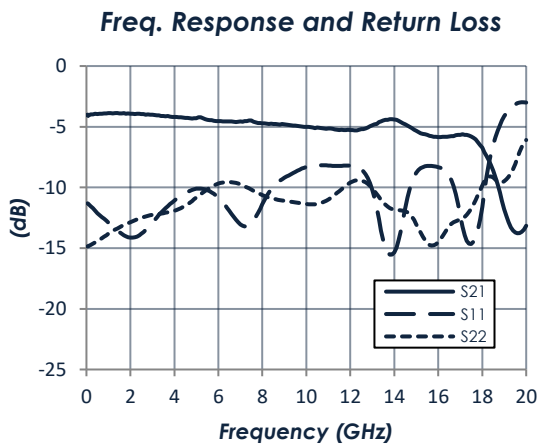

AM4001 - Splitter

2-18 GHz 2-Way 0° Splitter

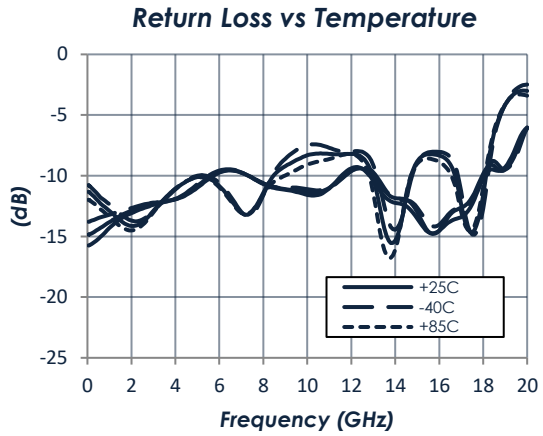
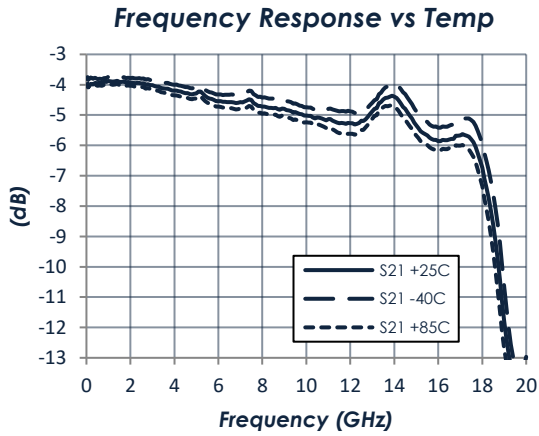

Additional Specifications

RF Impedance	50 ohms
Maximum RF Input	+27dBm
Operating Temperature Range	-40C to +85C
Storage Temperature Range	-50C to +125C

Typical Application Circuit

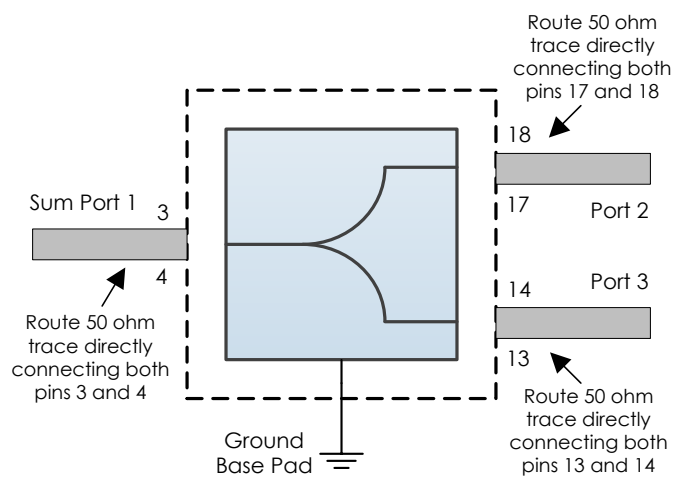

AM4001 - Splitter

2-18 GHz 2-Way 0° Splitter

Package Details and Footprint

Package Drawing

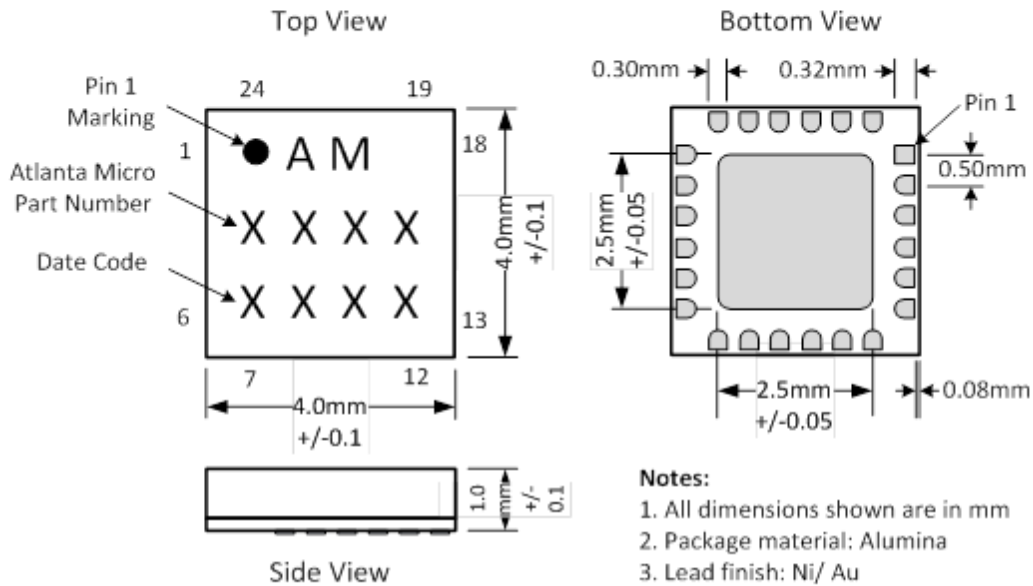

Recommended Footprint

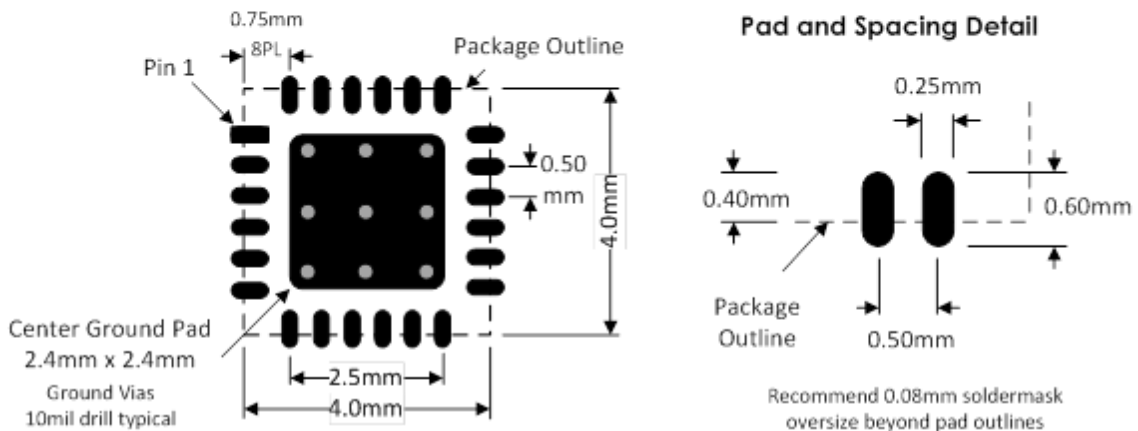

AM4001 - Splitter

2-18 GHz 2-Way 0° Splitter

Evaluation PC Board

