

AM3134 – Analog Tunable Filter

Dual 2.0 to 3.2 GHz and 2.5 to 4.5 GHz Bandpass

Description

AM3134 is a dual MMIC analog voltage-tunable bandpass filter covering the 2.0 to 3.2 GHz and 2.5 to 4.5 GHz frequency ranges. Separate low-pass and high-pass tuning voltages provide independent control of both center frequency and bandwidth. AM3134 is packaged in a 5mm QFN package and operates over the -40 C to +85 C temperature range.

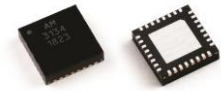

Features

- Analog Tuning
- Independent LP and HP Control
- 7.5 dB Typical Insertion Loss
- +31 dBm Typical IIP3
- +83 dBm Typical IIP2
- +1V to +10V Tuning Voltage
- 5mm QFN Package
- -40C to +85C Operation

Functional Diagram

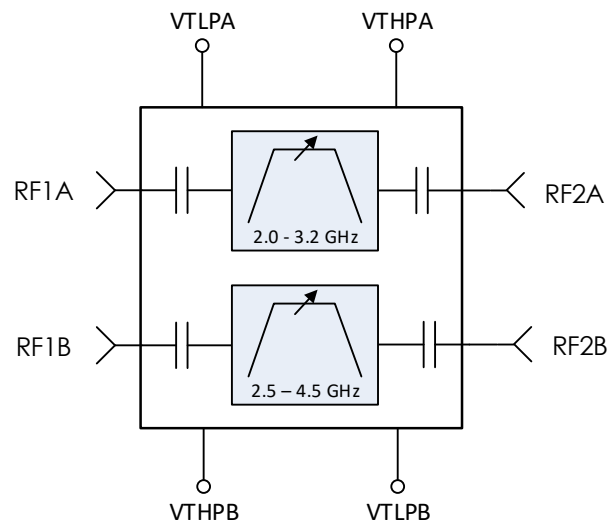

Characteristic Performance

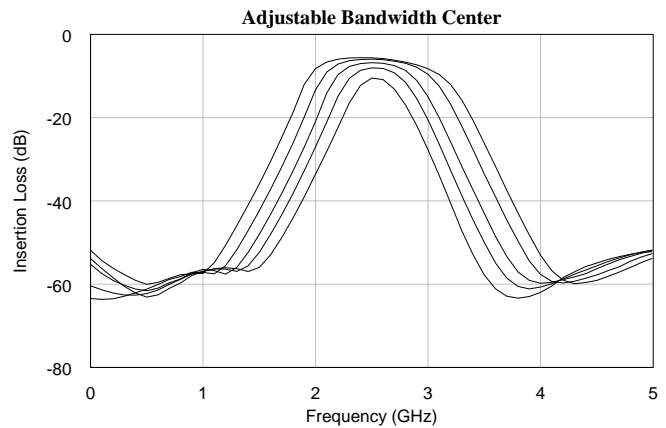
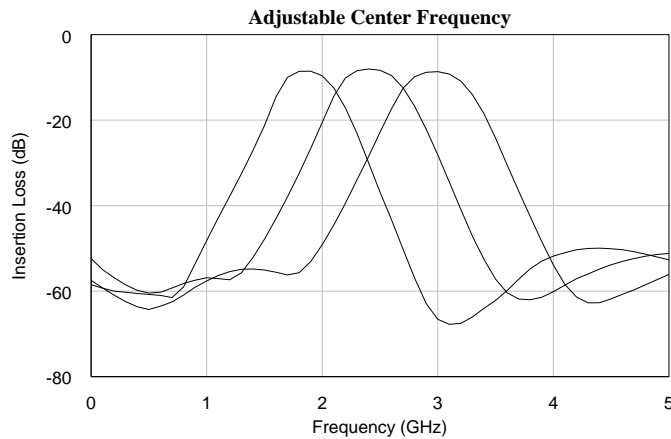

AM3134 – Analog Tunable Filter

Dual 2.0 to 3.2 GHz and 2.5 to 4.5 GHz Bandpass



Table of Contents

Description	1	RF Performance	5
Features	1	Timing Characteristics	5
Functional Diagram	1	Typical Performance	6
Characteristic Performance	1	Typical Application	9
Revision History	2	Independent Low Pass and High Pass Control.....	9
Pin Layout and Definitions	3	Single Control Voltage	10
Specifications	4	Package Details	11
Absolute Maximum Ratings.....	4	Evaluation PC Board	12
Handling Information	4	Related Parts	12
Recommended Operating Conditions....	4	Component Compliance Information	13
DC Electrical Characteristics	5		

Revision History

Date	Revision Number	Notes
March 15, 2018	1	Initial Release
March 2, 2020	2	Updated for Latest Datasheet Format. More Comprehensive Data Added.

AM3134 – Analog Tunable Filter

Dual 2.0 to 3.2 GHz and 2.5 to 4.5 GHz Bandpass



Pin Layout and Definitions

Note: All Non-Named Pins are NC. (Not Connected)

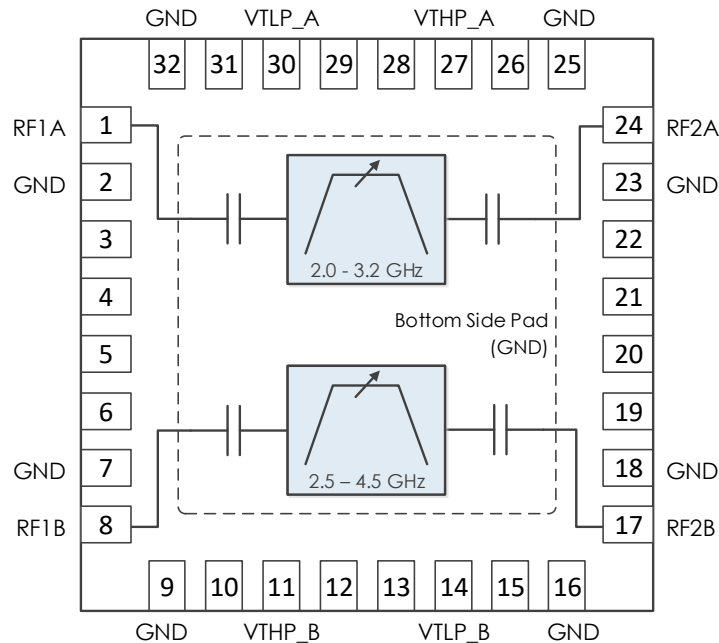

Pin Number	Pin Name	Pin Function
1	RF1A	RF1A – 50 Ohms – AC Coupled, No Blocking Cap Needed
2	GND	Ground – Common
3-6	NC	Not Connected, Recommended to Be Connected to Ground
7	GND	Ground – Common
8	RF1B	RF1B – 50 Ohms – AC Coupled, No Blocking Cap Needed
9	GND	Ground – Common
10	NC	Not Connected, Recommended to Be Connected to Ground
11	VTHP_B	High Pass DC Control Voltage, Channel B
12, 13	NC	Not Connected, Recommended to Be Connected to Ground
14	VTL_P_B	Low Pass DC Control Voltage, Channel B
15	NC	Not Connected, Recommended to Be Connected to Ground
16	GND	Ground – Common
17	RF2B	RF2B – 50 Ohms – AC Coupled, No Blocking Cap Needed
18	GND	Ground – Common
19 - 22	NC	Not Connected, Recommended to Be Connected to Ground
23	GND	Ground – Common
24	RF2A	RF2A – 50 Ohms – AC Coupled, No Blocking Cap Needed
25	GND	Ground – Common
26	NC	Not Connected, Recommended to Be Connected to Ground
27	VTHP_A	High Pass DC Control Voltage, Channel A
28, 29	NC	Not Connected, Recommended to Be Connected to Ground
30	VTL_P_A	Low Pass DC Control Voltage, Channel A
31	NC	Not Connected, Recommended to Be Connected to Ground
32	GND	Ground - Common
Bottom Pad	GND	Ground – Common

To obtain price, delivery, or to place an order contact sales@atlantamicro.com
 Atlanta Micro Inc., 3720 Davinci Ct, Suite 125, Peachtree Corners, GA 30092 • Phone: (470) 253-7640 • www.atlantamicro.com

AM3134 – Analog Tunable Filter

Dual 2.0 to 3.2 GHz and 2.5 to 4.5 GHz Bandpass

Specifications

Absolute Maximum Ratings

	Minimum	Maximum
DC Control Voltage	0.0 V	+12.0 V
RF Input Power		+27 dBm
Operating Junction Temperature	-40 C	+150 C
Storage Temperature Range	-50 C	+150 C

Note: Any device operation beyond the Absolute Maximum Ratings may result in permanent damage to the device. The values listed in this table are extremes and do not imply functional operation of the device at these or any other conditions beyond what is listed under Recommended Operating Conditions. Any part subjected to conditions outside of what is recommended for an extended amount of time may suffer from reliability concerns.

Handling Information

	Minimum	Maximum
Storage Temperature Range (Recommended)	-50 C	+125 C
Moisture Sensitivity Level	MSL 3	



Atlanta Micro products are electrostatic sensitive.
Follow safe handling practices to avoid damage

Recommended Operating Conditions

	Minimum	Typical	Maximum
DC Control Voltage	+1.0 V		+10.0 V
Operating Case Temperature	-40 C		+85 C
Operating Junction Temperature	-40 C		+125 C

AM3134 – Analog Tunable Filter

Dual 2.0 to 3.2 GHz and 2.5 to 4.5 GHz Bandpass

DC Electrical Characteristics

(T = 25 °C unless otherwise specified)

Parameter	Testing Conditions	Minimum	Typical	Maximum
DC Control Voltage		+1.0 V		+10.0 V
DC Supply Current			< 1 mA	

RF Performance

(T = 25 °C unless otherwise specified)

Parameter	Testing Conditions	Minimum	Typical	Maximum
Frequency Range	Band A	2.0 GHz		3.2 GHz
	Band B	2.5 GHz		4.5 GHz
Insertion Loss			7.5 dB	
Return Loss			15 dB	
Input IP3	Band A		+30 dBm	
	Band B		+31 dBm	
Input IP2	Band A		+83 dBm	
	Band B		+76 dBm	
Input P1dB			+25 dBm	

Timing Characteristics

Parameter	Minimum	Typical	Maximum
Tune Voltage Settling Time			2 μ s / V

AM3134 – Analog Tunable Filter

Dual 2.0 to 3.2 GHz and 2.5 to 4.5 GHz Bandpass

Typical Performance

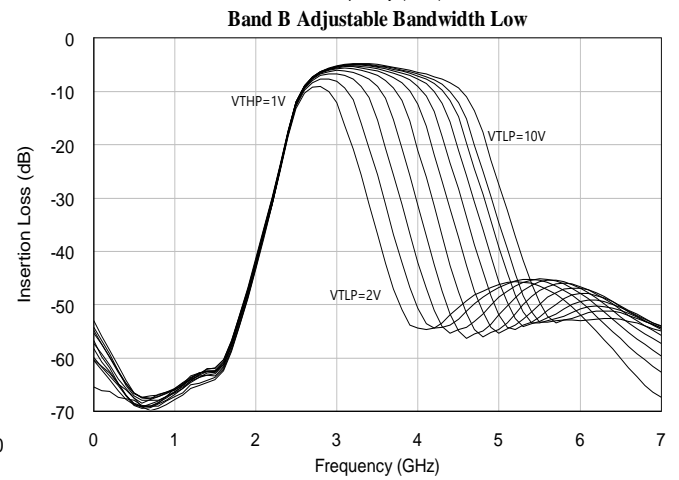
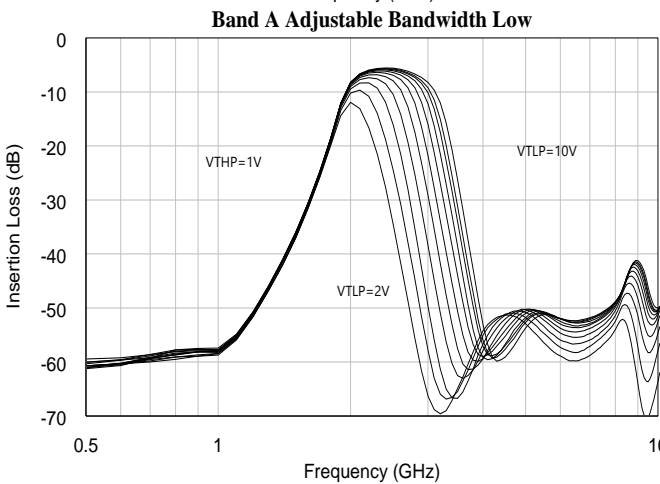
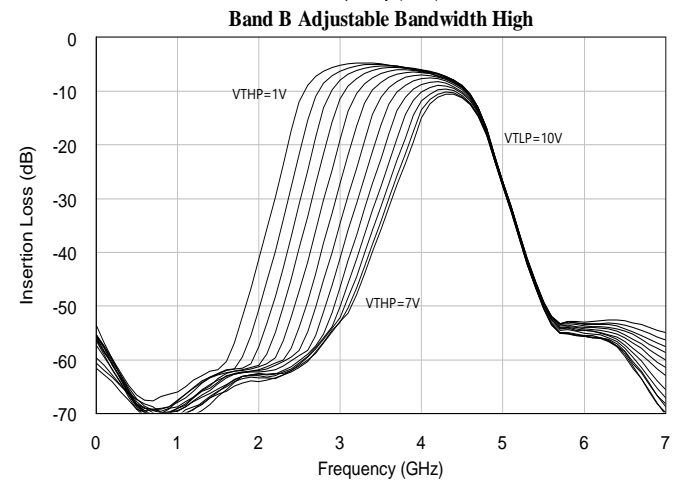
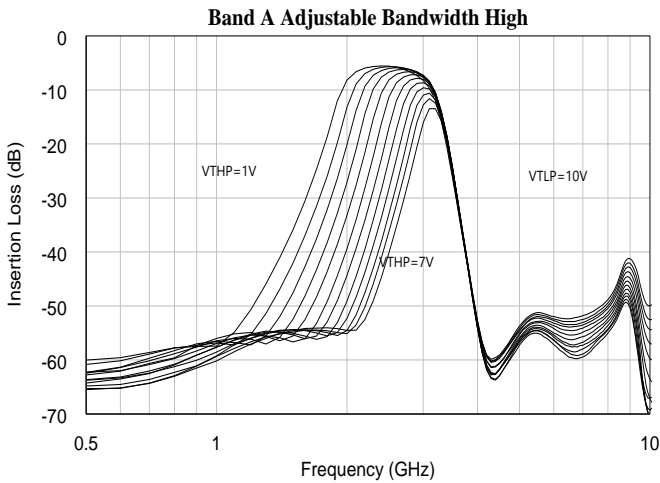
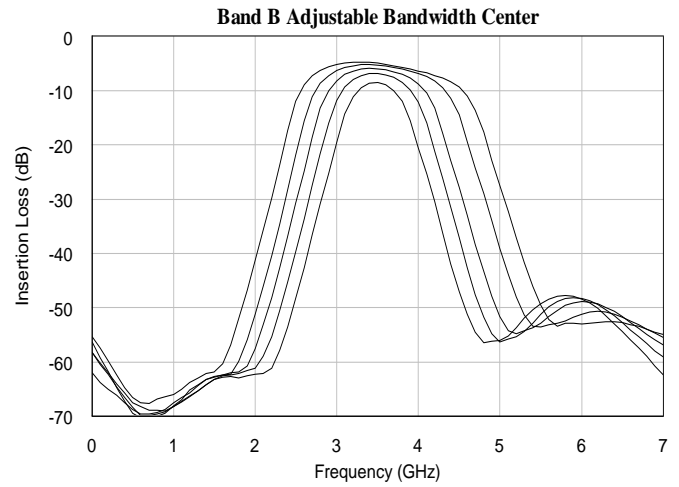
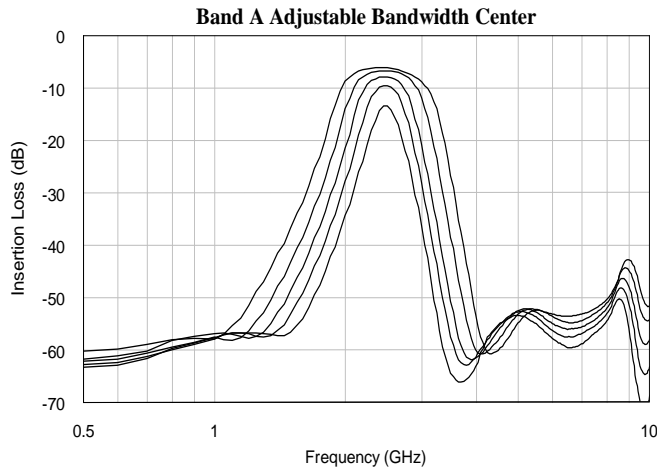

AM3134 – Analog Tunable Filter

Dual 2.0 to 3.2 GHz and 2.5 to 4.5 GHz Bandpass

Typical Performance (continued)

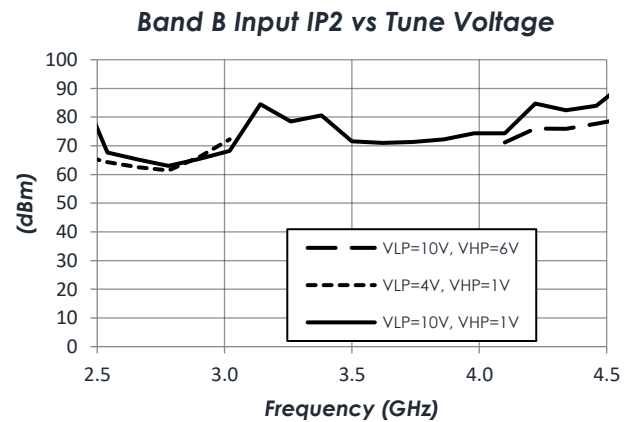
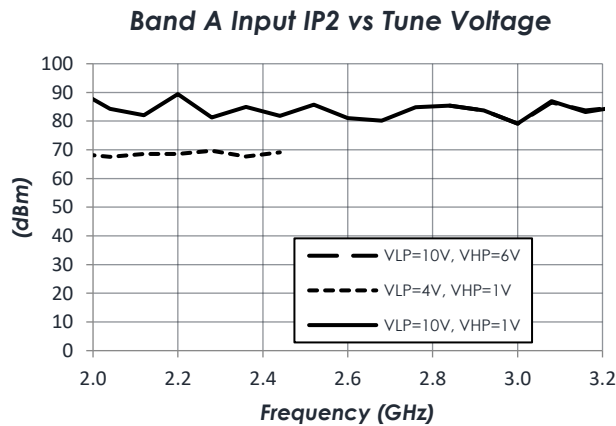
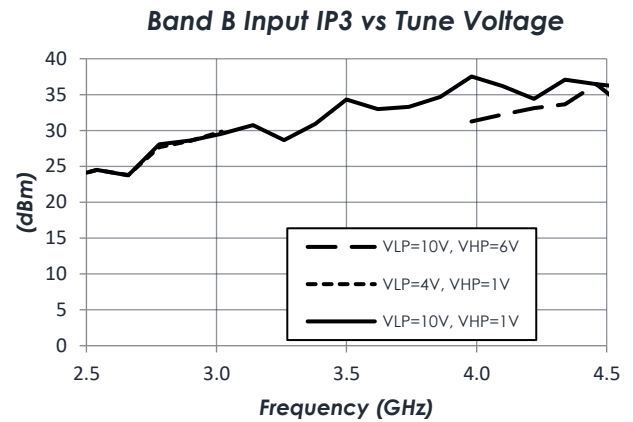
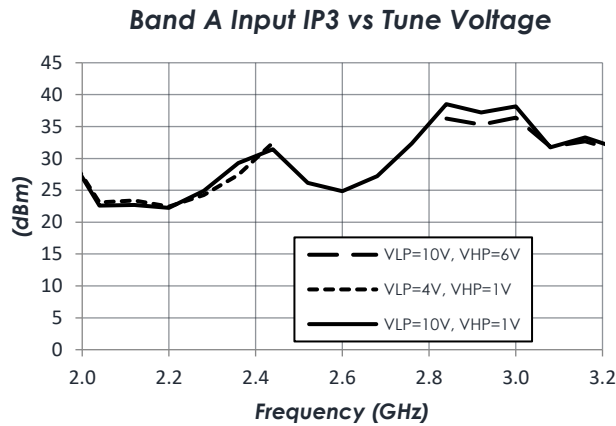
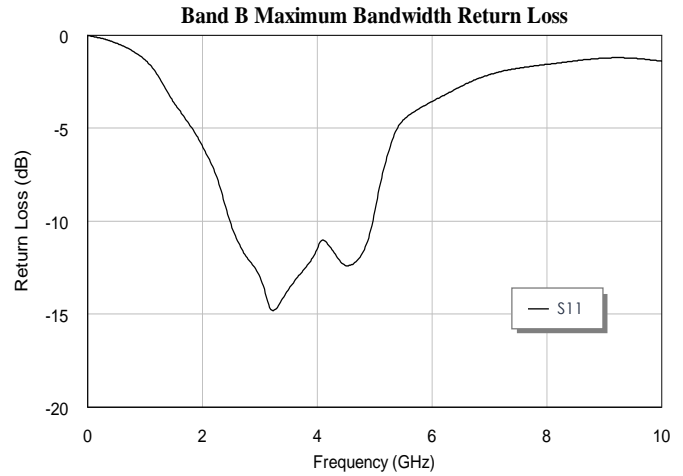
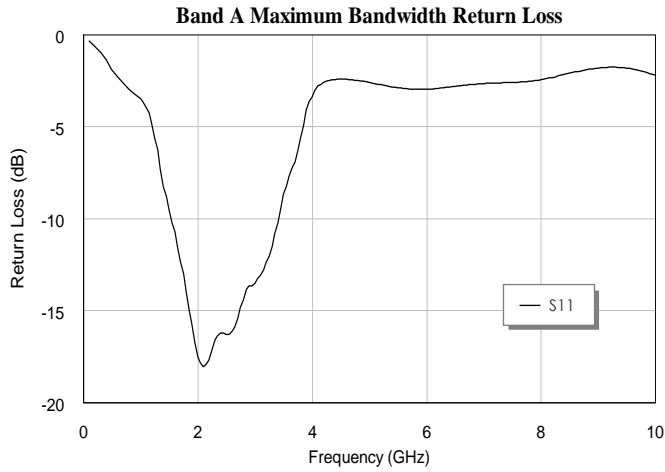

AM3134 – Analog Tunable Filter

Dual 2.0 to 3.2 GHz and 2.5 to 4.5 GHz Bandpass

Typical Performance (continued)

(VLP=10V, VHP=1V unless otherwise specified)

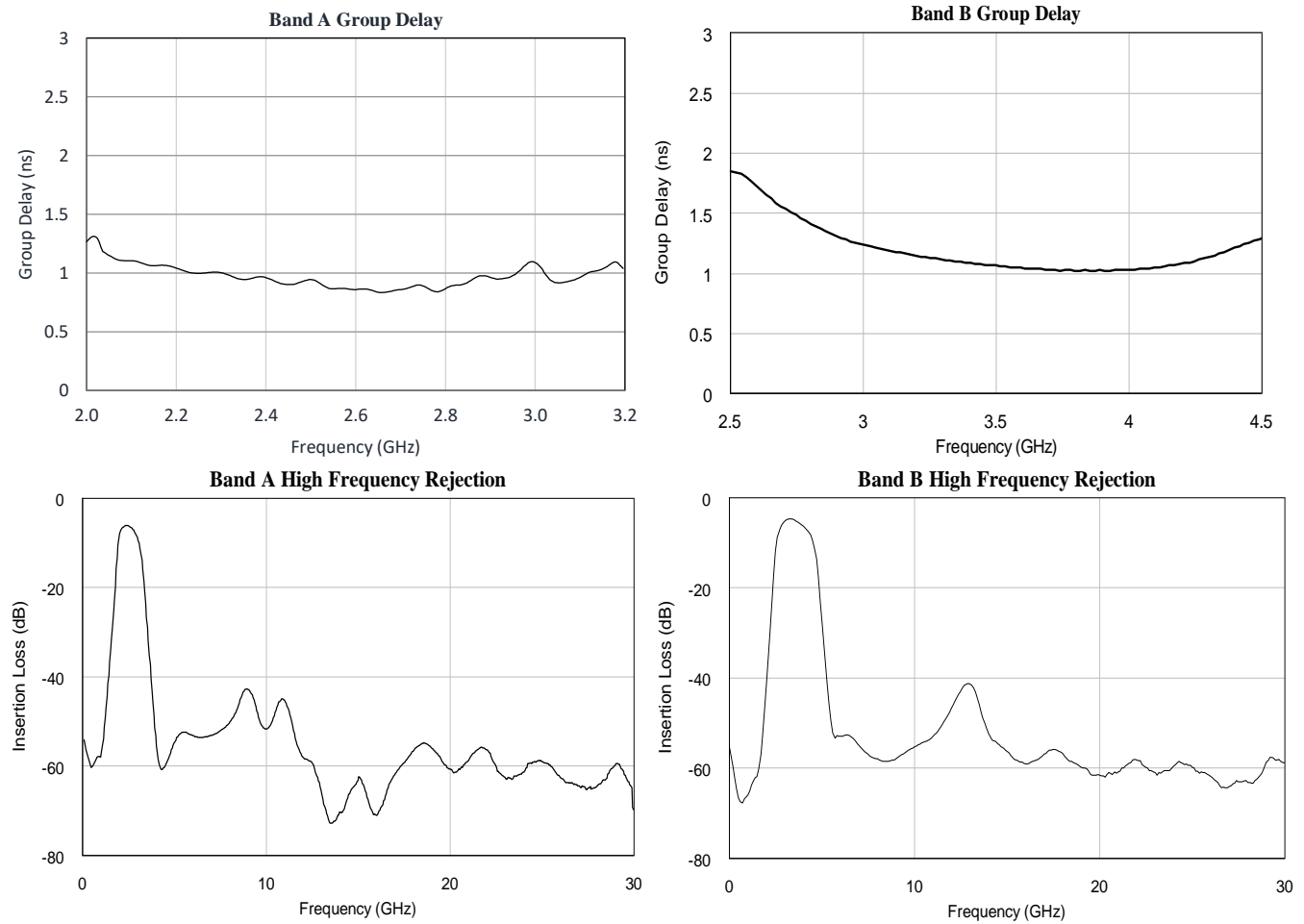

AM3134 – Analog Tunable Filter

Dual 2.0 to 3.2 GHz and 2.5 to 4.5 GHz Bandpass



Typical Application

Independent Low Pass and High Pass Control

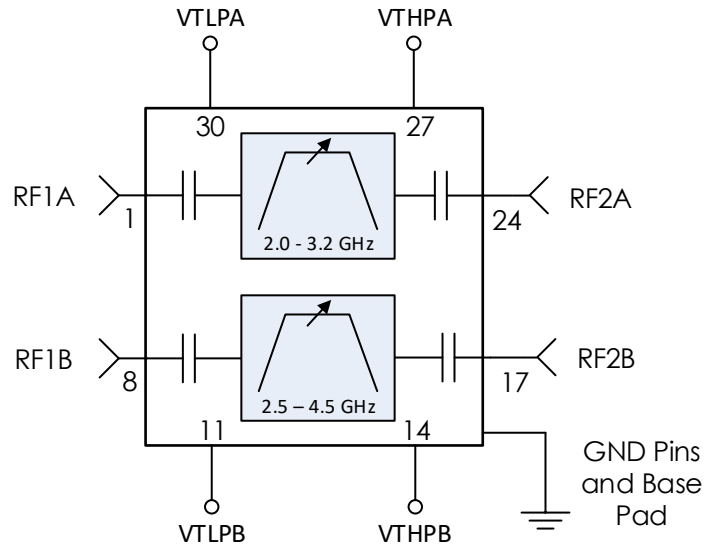

Notes:

1. RC filtering on the control lines is recommended to prevent digital noise from coupling to the RF path.
 - a. Select control line RC filter values based on desired logic source decoupling and switching speed.

AM3134 – Analog Tunable Filter

Dual 2.0 to 3.2 GHz and 2.5 to 4.5 GHz Bandpass



Typical Application

Single Control Voltage

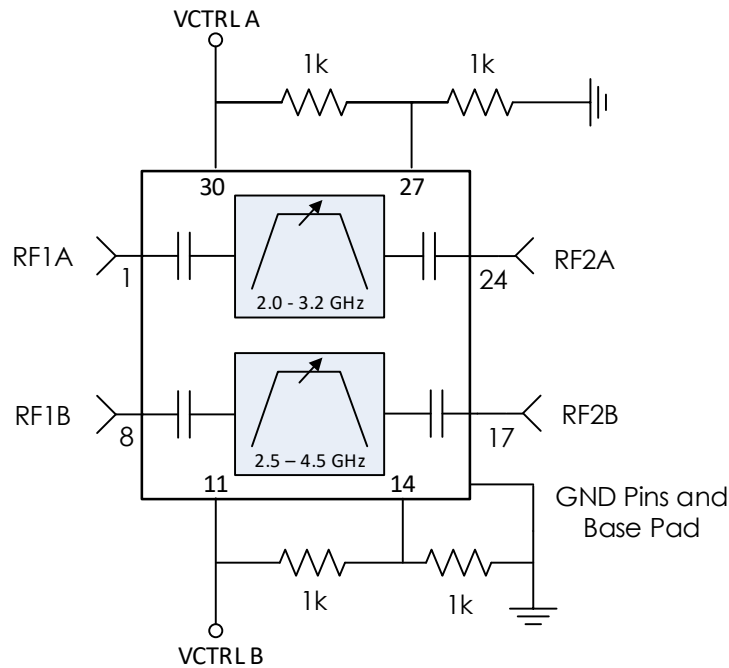

Notes:

- RC filtering on the control lines is recommended to prevent digital noise from coupling to the RF path.
 - Select control line RC filter values based on desired logic source decoupling and switching speed.
- The resistive dividers between pins 11 and 14 and 27 and 30 exist to normalize percentage bandwidth over the full 1-10 V range. Tying both pins to the same control voltage without the divider is possible, but the bandwidth will be narrower with higher insertion loss over the tuning range.

2.0 to 3.2 GHz Single Control Voltage:

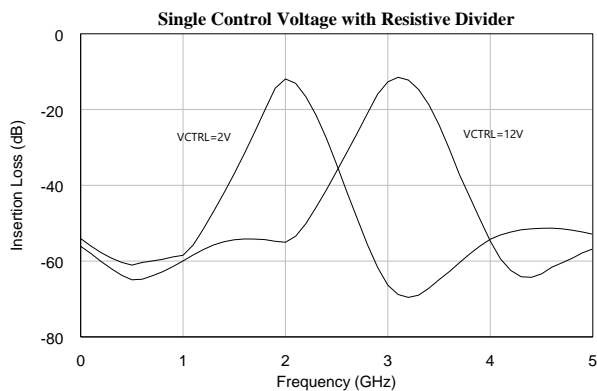

2.5 to 4.5 GHz Single Control Voltage:

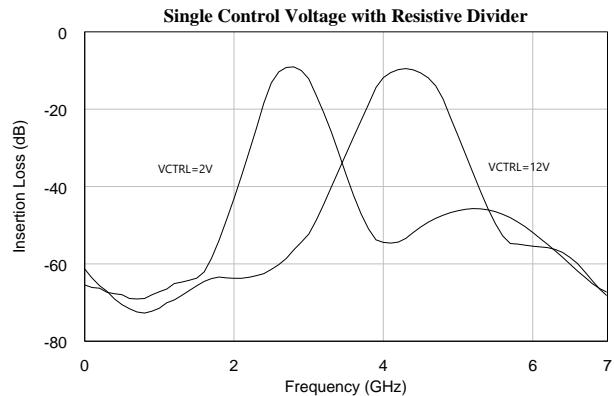

AM3134 – Analog Tunable Filter

Dual 2.0 to 3.2 GHz and 2.5 to 4.5 GHz Bandpass



Package Details

Package Drawing

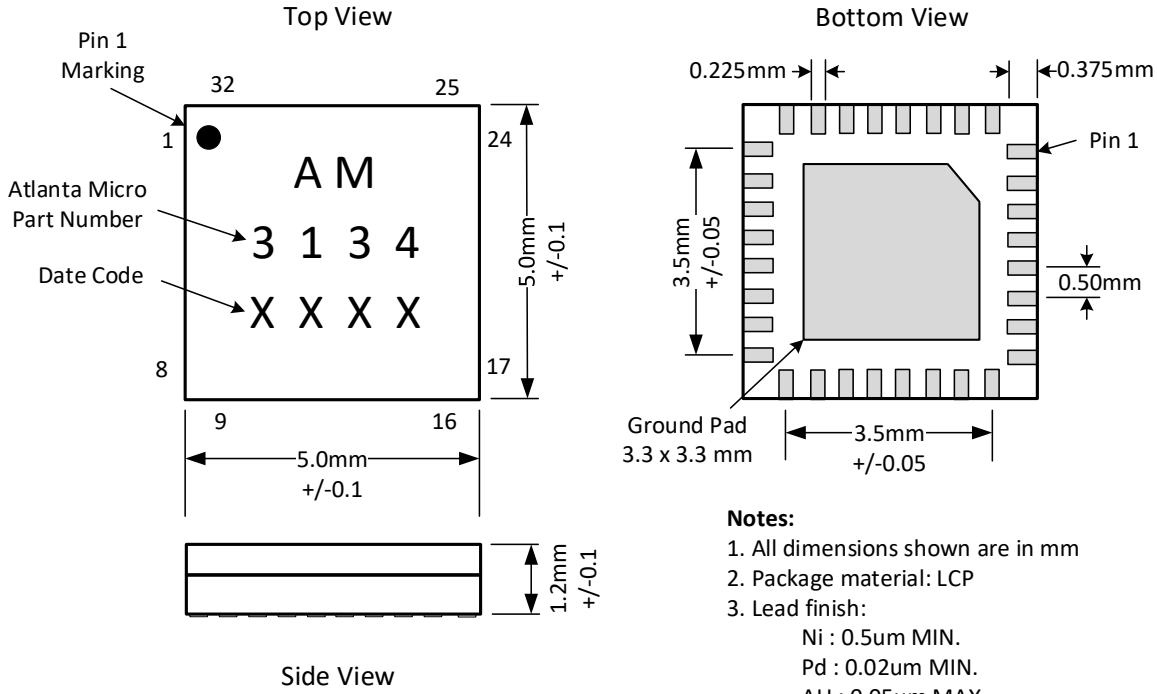

Recommended Footprint

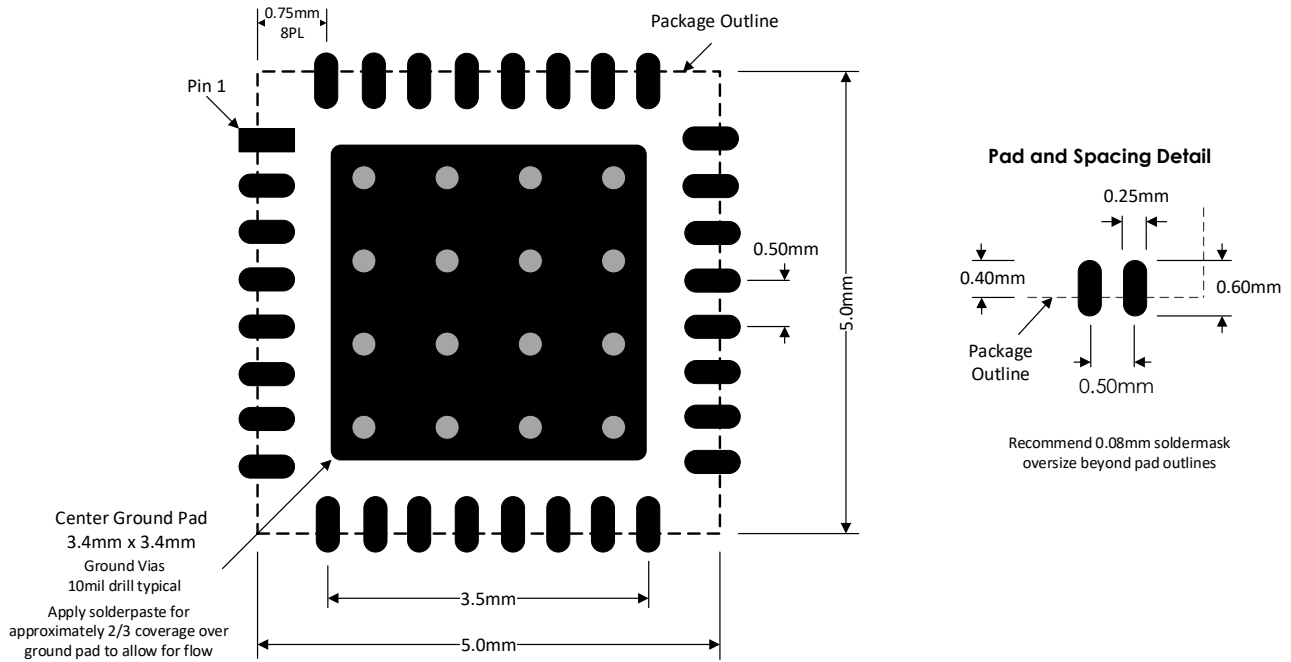

AM3134 – Analog Tunable Filter

Dual 2.0 to 3.2 GHz and 2.5 to 4.5 GHz Bandpass

Evaluation PC Board

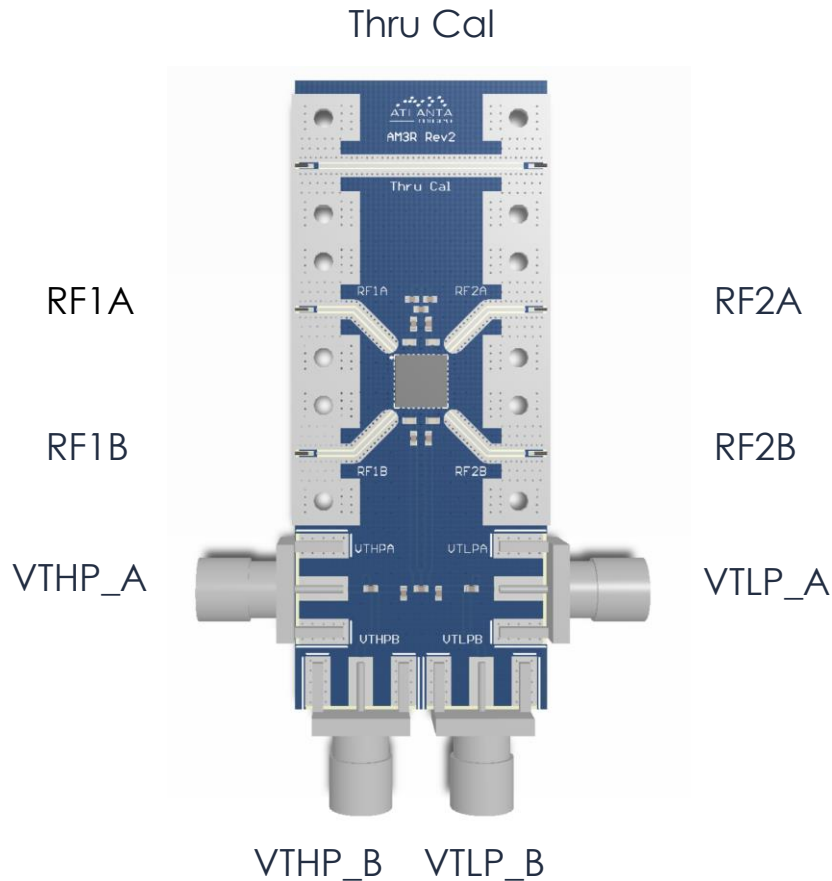

Related Parts

Part Number	Description			
AM3063	6.0 GHz	to	18.0 GHz	Digitally Tunable Bandpass Filter Bank
AM3064	1.0 GHz	to	6.5 GHz	Digitally Tunable Bandpass Filter Bank
AM3066	12.0 GHz	to	26.5 GHz	Digitally Tunable Bandpass Filter Bank
AM3135	3.5 GHz	to	9.0 GHz	Analog Tunable Bandpass Filter Bank
AM3136	8.0 GHz	to	19.0 GHz	Analog Tunable Bandpass Filter Bank
AM3089	2.0 GHz	to	18.0 GHz	Analog Tunable Bandpass Filter Bank
AM3137	700 MHz	to	2.0 GHz	Analog Tunable Notch Filter Bank
AM3138	1.3 GHz	to	3.25 GHz	Analog Tunable Notch Filter Bank
AM3139	2.5 GHz	to	6.0 GHz	Analog Tunable Notch Filter Bank

AM3134 – Analog Tunable Filter

Dual 2.0 to 3.2 GHz and 2.5 to 4.5 GHz Bandpass



Component Compliance Information

RoHS: Atlanta Micro, Inc. hereby certifies that all products comply with the EC Directive 2011/65/EC on the Restriction of Hazardous Substances, commonly known as EU-RoHS 6 and 10. All products supplied by Atlanta Micro shall be compliant with the European Directive 2011/65/EC based on the following substance list.

Substance List	Allowable Maximum Concentration
Lead (Pb)	<1000 PPM (0.1% by weight)
Mercury (Hg)	<1000 PPM (0.1% by weight)
Cadmium (Cd)	<75 PPM (0.0075% by weight)
Hexavalent Chromium (CrVI)	<1000 PPM (0.1% by weight)
Polybrominated Biphenyls (PBB)	<1000 PPM (0.1% by weight)
Polybrominated Diphenyl ethers (PBDE)	<1000 PPM (0.1% by weight)
Decabromodiphenyl Deca BDE	<1000 PPM (0.1% by weight)
Bis (2-ethylhexyl) Phthalate (DEHP)	<1000 PPM (0.1% by weight)
Butyl Benzyl Phthalate (BBP)	<1000 PPM (0.1% by weight)
Dibutyl Phthalate (DBP)	<1000 PPM (0.1% by weight)
Diisobutyl Phthalate (DIBP)	<1000 PPM (0.1% by weight)

REACH: Atlanta Micro, Inc. neither uses nor intentionally adds any of the substances considered to be a Substance of Very High Concern (SVHC) as defined by the EU Regulation (EC) No. 1907-2006 on Registration, Evaluation, Authorization, and Restriction of Chemicals (REACH).

Conflict Materials: Atlanta Micro does not knowingly use materials that are sourced from the Democratic Republic of Congo (DRC) or any other known conflict regions. Atlanta Micro's supply chain is comprised of sources that are both environmentally and socially responsible. We periodically review this requirement with our vendors to ensure continued compliance.

Atlanta Micro takes its responsibility as a global partner seriously and will use due diligence within our supply chain to ensure all standards are met to the best of our knowledge.