

AM3025A – Filter Bank

Miniature Transmit / Receive with Sub-Octave Filtering

Description

AM3025A is a miniature filter bank with 7 sub-octave filters covering the 400 MHz to 6000 MHz frequency range with full 80-MHz overlap available in a 9mm 24 lead QFN package or a USB controlled RF-shielded module. The device provides ports for a filter bypass path and supports both transmit and receive applications. AM3025A is an excellent front-end / back-end for a broadband receiver, transmitter, or transceiver requiring high dynamic range and small size, weight, and power consumption (low SWaP).

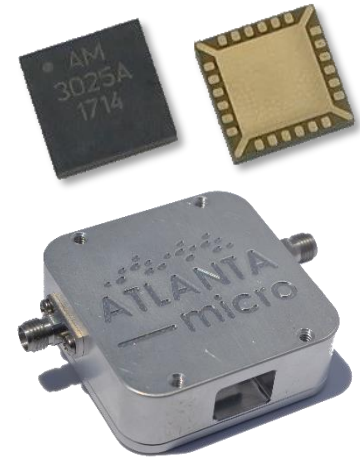

Features

- Sub-Octave Filter Bank
- 6 dB Insertion Loss
- 3 dB Insertion Loss Bypass Path
- +3.3V to +5V Supply
- +3V to +5V Control
- 0.09 Watts Power Consumption
- 9mm QFN Package
- -40C to +85C Operation
- Available in RF Shielded Module

Functional Diagram

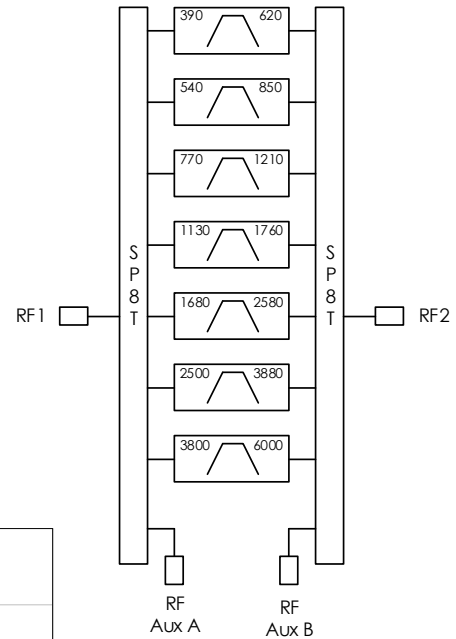

Characteristic Performance

Typical Frequency Response

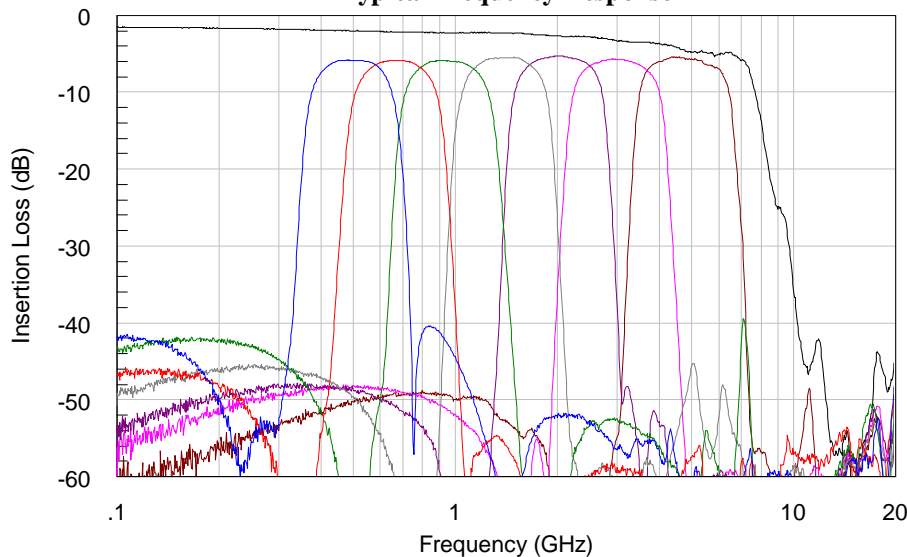

Table of Contents

Description	1	RF Performance	5
Features	1	Timing Characteristics	5
Functional Diagram	1	State Table	5
Characteristic Performance	1	Typical Performance	6
Revision History	2	Typical Application	9
Pin Layout and Definitions	3	Part Ordering Details	10
Specifications	4	Related Parts	10
Absolute Maximum Ratings	4	9mm 24 Lead QFN Details	11
Handling Information	4	Evaluation PC Board Details	12
Recommended Operating Conditions	4	RF Shielded Module Details	13
DC Electrical Characteristics	5	Component Compliance Information	14

Revision History

Date	Revision Number	Notes
January 29, 2019	A4	Maximum input power updated.
April 8, 2019	5	Updated to new datasheet format. More comprehensive part data included.
June 7, 2019	6	Added information about connectorized AM3025A module. Component compliance information updated.
June 13, 2019	6A	Added module photo to front page.
July 24, 2019	7	Updated 9mm 24 Lead QFN Details with plating thicknesses
September 10, 2019	8	Added additional part ordering options.

AM3025A – Filter Bank

Miniature Transmit / Receive with Sub-Octave Filtering



Pin Layout and Definitions

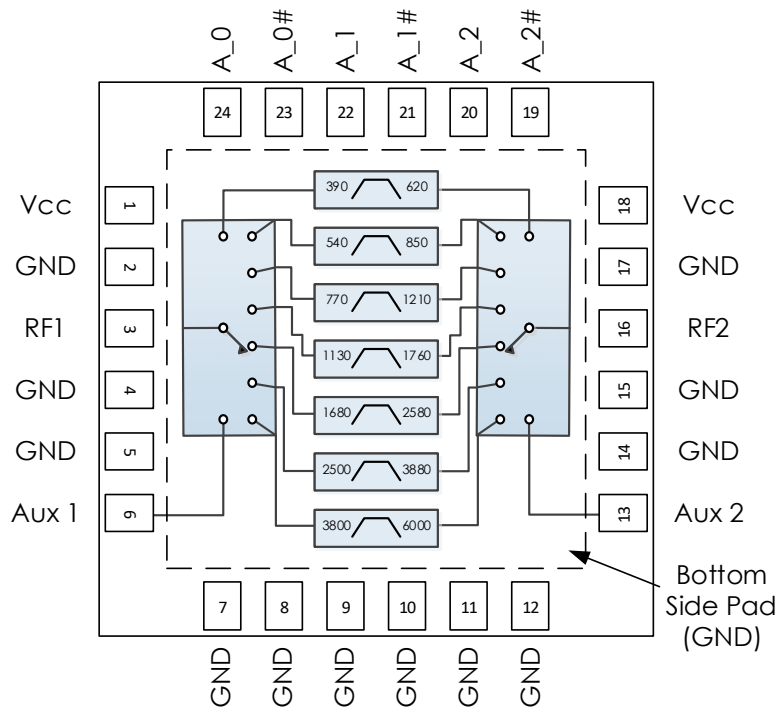

Pin Number	Pin Name	Pin Function
1	Vcc	DC Power Input
2	GND	Ground – Common
3	RF 1	RF Port 1 – 50 Ohms – DC Coupled, External Blocking Capacitor Required*
4, 5	GND	Ground – Common
6	RF Aux 1	Optional 2 MHz to 6 GHz RF port – Pin 13 Return ** - 50 Ohms – DC Coupled, External Blocking Capacitor Required*
7-12	GND	Ground – Common
13	RF Aux 2	Optional 2 MHz to 6 GHz RF port – Pin 6 Return ** - 50 Ohms – DC Coupled, External Blocking Capacitor Required*
14, 15	GND	Ground – Common
16	RF 2	RF Port 2 – 50 Ohms – DC Coupled, External Blocking Capacitor Required*
17	GND	Ground – Common
18	Vcc	DC Power Input
19	A_2#	Complement of Filter Band Select A_2
20	A_2	Filter Band Select A_2
21	A_1#	Complement of Filter Band Select A_1
22	A_1	Filter Band Select A_1
23	A_0#	Complement of Filter Band Select A_0
24	A_0	Filter Band Select A_0
Bottom Pad	GND	Ground – Common

***Note:** DC blocking caps not required if in series with other Atlanta Micro parts of the same reference voltage.

****Note:** Can be used for external filtering or connected through a coupling capacitor to return pin for a filter bypass path.

AM3025A – Filter Bank

Miniature Transmit / Receive with Sub-Octave Filtering

Specifications

Absolute Maximum Ratings

	Minimum	Maximum
Supply Voltage	-0.3 V	+6 V
RF Input Power		+27 dBm
Operating Junction Temperature	-40 C	+150 C
Storage Temperature Range	-50 C	+150 C

Note: Any device operation beyond the Absolute Maximum Ratings may result in permanent damage to the device. The values listed in this table are extremes and do not imply functional operation of the device at these or any other conditions beyond what is listed under Recommended Operating Conditions. Any part subjected to conditions outside of what is recommended for an extended amount of time may suffer from reliability concerns.

Handling Information

	Minimum	Maximum
Storage Temperature Range (Recommended)	-50 C	+125 C
Moisture Sensitivity Level	MSL 3	



Atlanta Micro products are electrostatic sensitive.
Follow safe handling practices to avoid damage

Recommended Operating Conditions

	Minimum	Typical	Maximum
Supply Voltage	+3.1 V	+3.3 V	+5.2 V
Operating Case Temperature	-40 C		+85 C
Operating Junction Temperature	-40 C		+125 C

AM3025A – Filter Bank

Miniature Transmit / Receive with Sub-Octave Filtering

DC Electrical Characteristics

(T = 25 °C unless otherwise specified)

Parameter	Testing Conditions	Minimum	Typical	Maximum
DC Supply Voltage		+3.1 V	+3.3 V	+5.2 V
DC Supply Current	V _{CC} = +3.3 V		14 mA	
	V _{CC} = +5.0 V		18 mA	
Control Line Current			<1 mA	
Power Dissipated	V _{CC} = +3.3 V		0.05 W	
	V _{CC} = +5.0 V		0.09 W	
Logic Level Low	V _{CC} = +3.3 V	-0.1 V		+0.4 V
	V _{CC} = +5.0 V	-0.1 V		+0.5 V
Logic Level High		+2.0 V		V _{CC}

RF Performance

(T = 25 °C unless otherwise specified)

Parameter	Testing Conditions	Minimum	Typical	Maximum
Frequency Range		1 MHz		6 GHz
Insertion Loss	Filter Activated		6 dB	
	Bypass Activated		3 dB	
Input IP3			+45 dBm	

Timing Characteristics

Parameter	Minimum	Typical	Maximum
Switching Speed (In Band → Out of Band)		150 ns	250 ns
Switching Speed (Out of Band → In Band)		250 ns	400 ns

Note: Switching speed measured without any control line filters. Switching speed measured as time from 50% control to 50% RF.

State Table

A_0	A_1	A_2	A_0#	A_1#	A_2#	Filter Band
Low	Low	Low	High	High	High	RF Aux 1 / RF Aux 2
Low	Low	High	High	High	Low	390 – 620 MHz
High	High	High	Low	Low	Low	540 – 850 MHz
High	High	Low	Low	Low	High	770 – 1210 MHz
Low	High	Low	High	Low	High	1130 – 1760 MHz
High	Low	High	Low	High	Low	1680 – 2580 MHz
High	Low	Low	Low	High	High	2500 – 3880 MHz
Low	High	High	High	Low	Low	3800 – 6000 MHz

AM3025A – Filter Bank

Miniature Transmit / Receive with Sub-Octave Filtering

Typical Performance

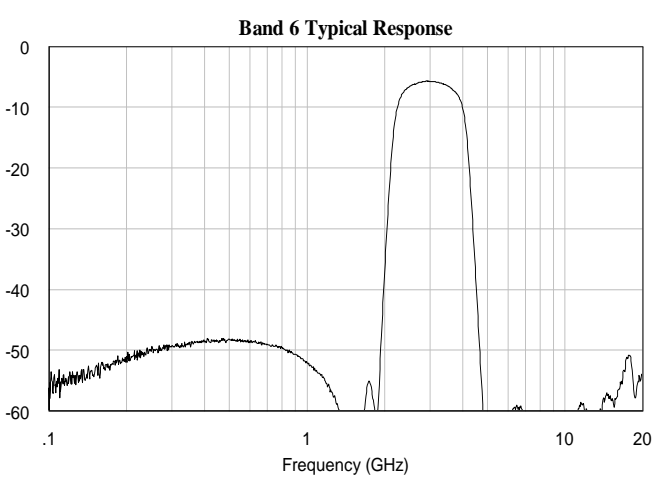
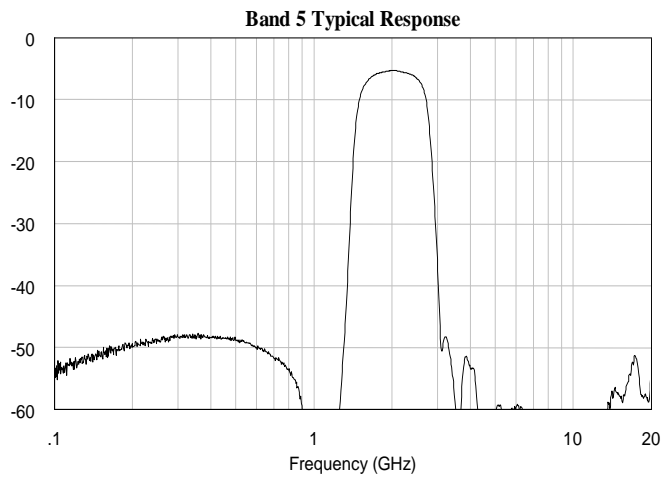
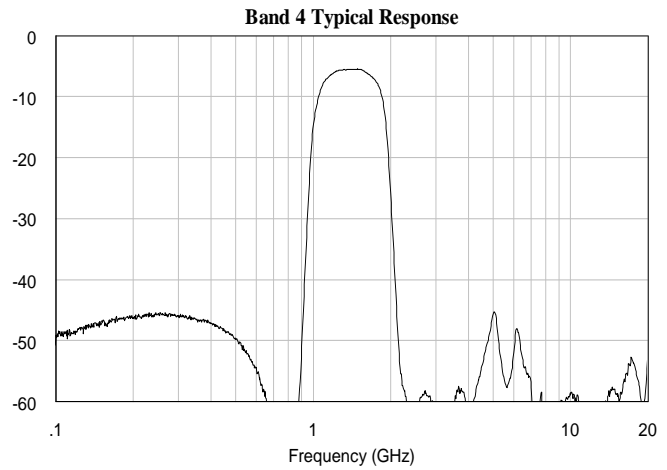
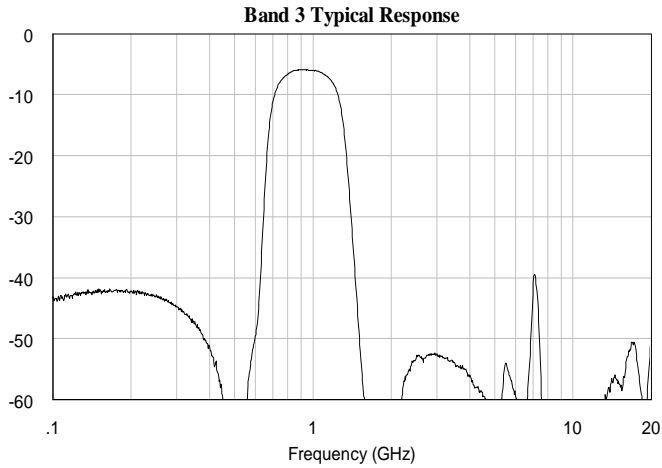
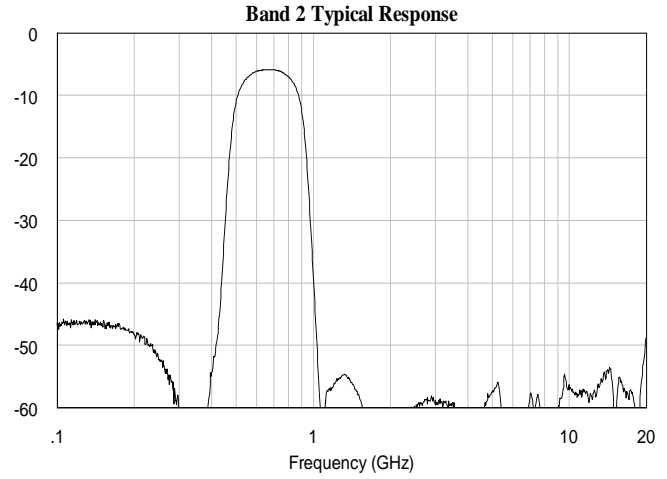
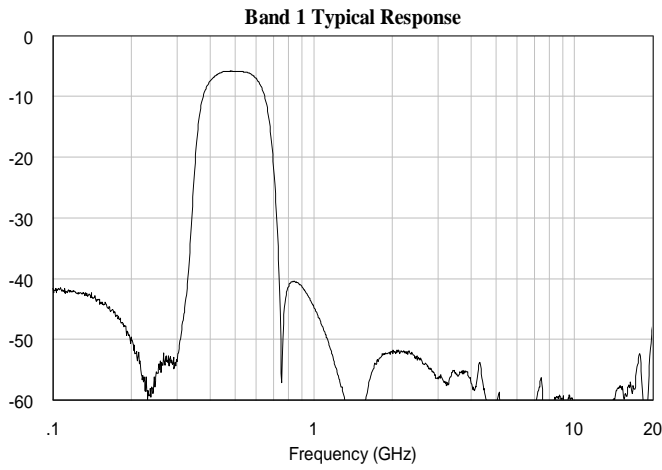

AM3025A – Filter Bank

Miniature Transmit / Receive with Sub-Octave Filtering

Typical Performance (continued)

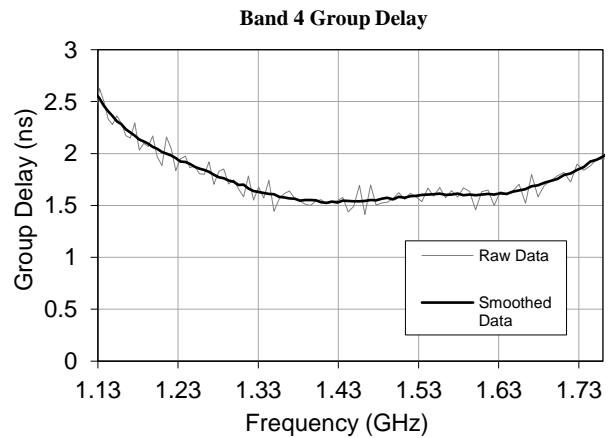
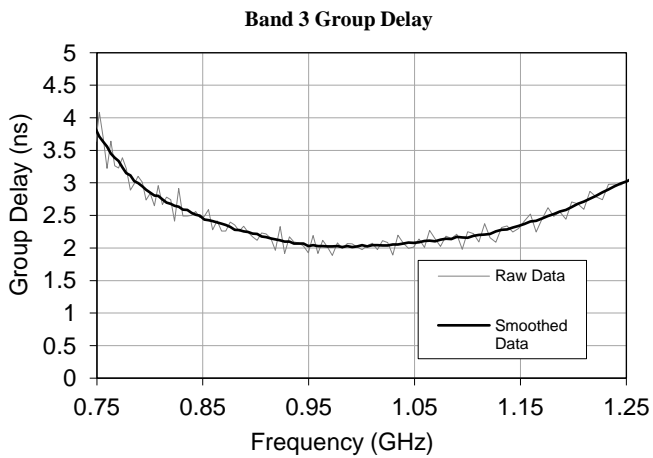
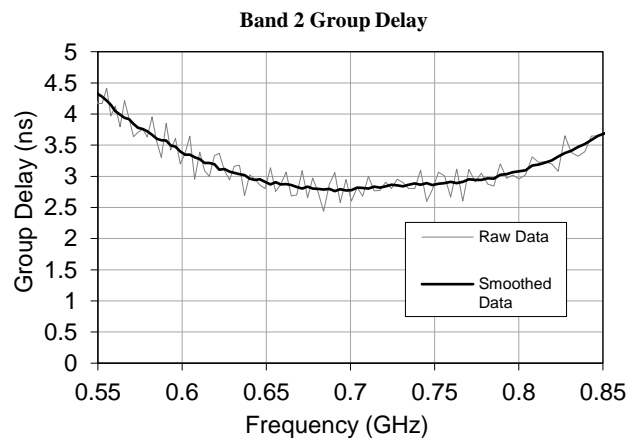
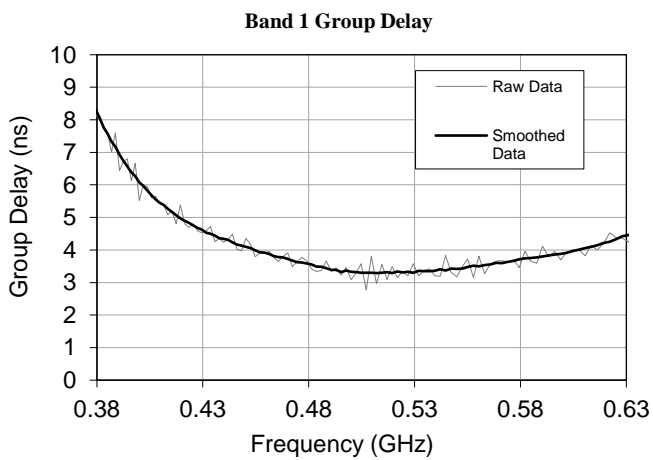
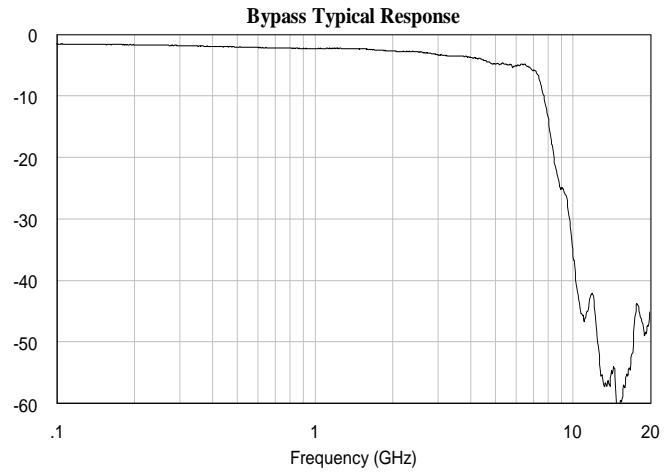
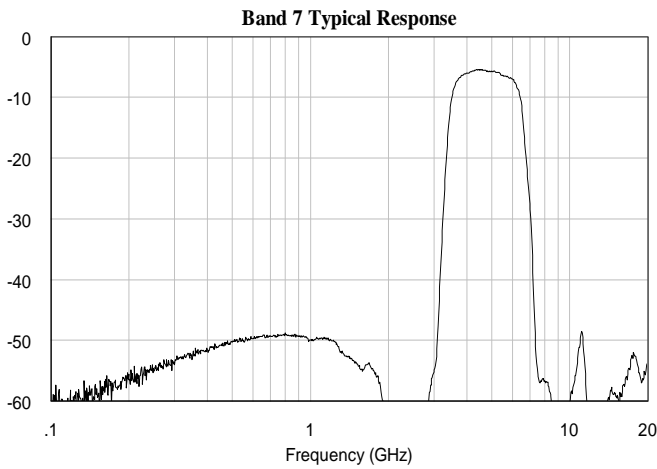

AM3025A – Filter Bank

Miniature Transmit / Receive with Sub-Octave Filtering

Typical Performance (continued)

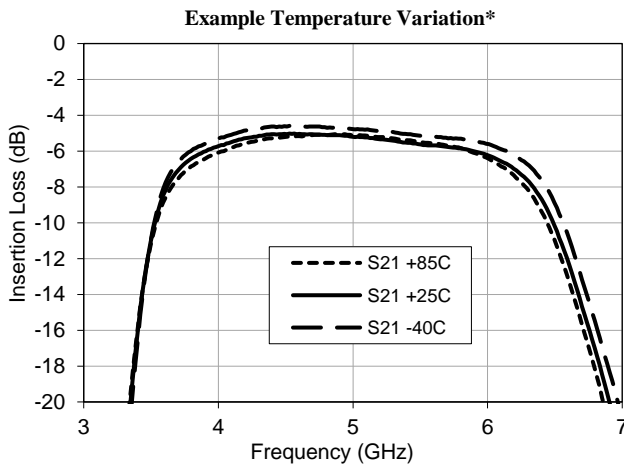
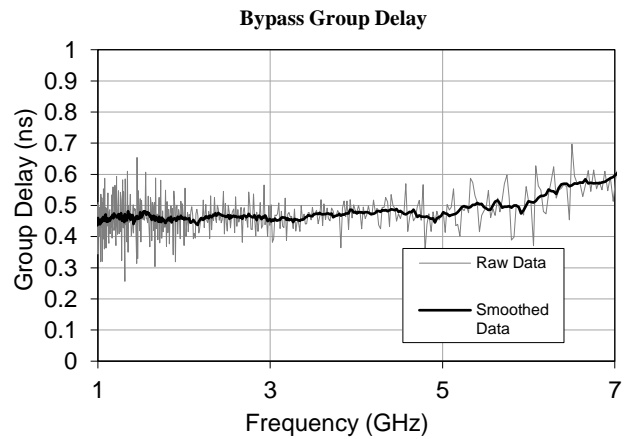
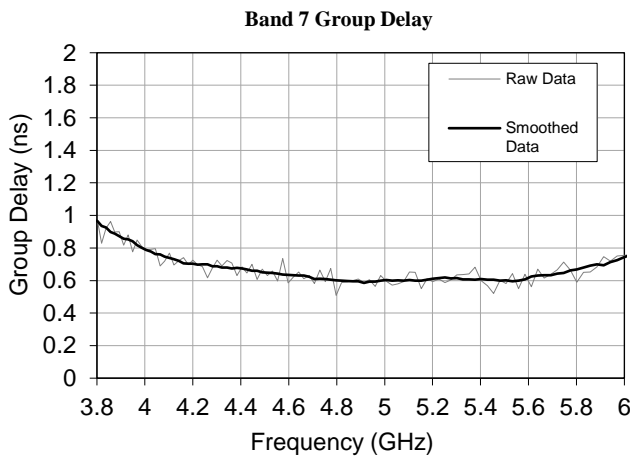
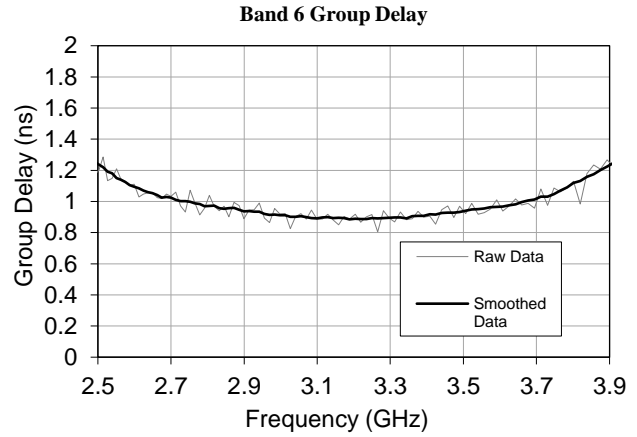
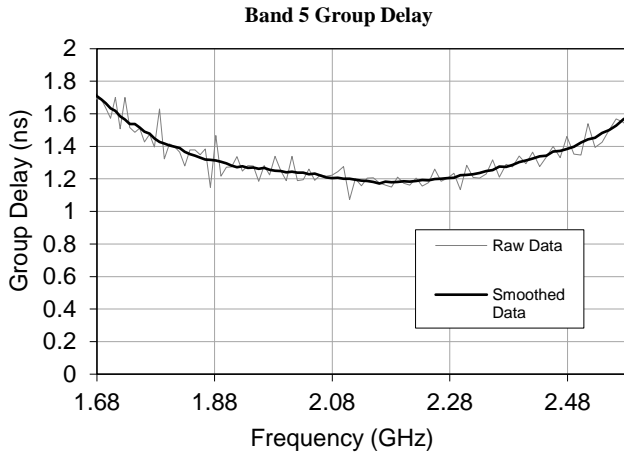

*Note: Band 7 shown.

AM3025A – Filter Bank

Miniature Transmit / Receive with Sub-Octave Filtering

Typical Application

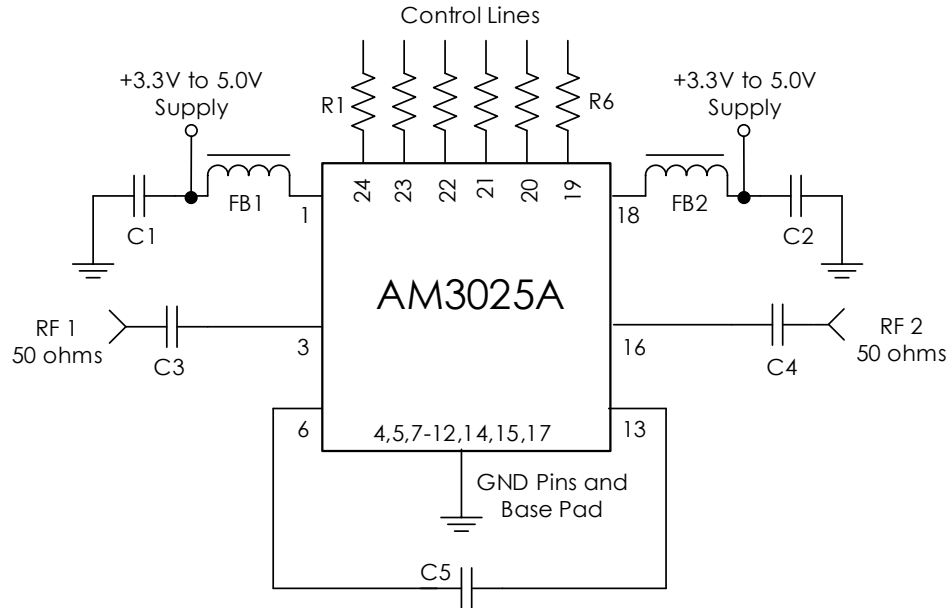

Recommended Component List (or equivalent):

Part	Value	Part Number	Manufacturer
C1, C2	0.1 μ F	GRM155R71C104KA88	Murata
C3, C4, C5	0.1 μ F	0402BB104KW160	Passives Plus
FB1, FB2		MMZ1005A222E	TDK
R1 – R6	100 Ω	CRCW0402100RFKED	Vishay

Notes:

1. C3, C4, and C5 should be high performance, low-loss, broadband capacitors for optimum performance.
2. RC filtering on the control lines is recommended to prevent digital noise from coupling to the RF path.
 - a. Select control line RC filter values based on desired logic source decoupling and switching speed.

AM3025A – Filter Bank



Miniature Transmit / Receive with Sub-Octave Filtering

Part Ordering Details

Description		Part Number
9mm 24 Lead QFN		AM3025A
AM3025A IC on PCB with Thru Cal, USB or Manual Control, and SMA or Header Pin Voltage Input	Manual Control	AM3025A Eval
	Manual/USB Control	AM3025A Eval with USB
AM3025A in 1.85"x1.85"x0.65" RF-Shielded Module with USB Power / Control and Field Replaceable SMA Connectors		AM3025A-M

Related Parts

Part Number	Description			
AM3023B	100 MHz	to	6 GHz	Switched Sub-Octave Filter Bank w/ Bypassable Amplifier
AM3024B	100 MHz	to	6 GHz	Switched Sub-Octave Filter Bank w/ Bypassable Amplifier
AM3060	320 MHz	to	6.5 GHz	Switched Digitally Tunable Preselector Filter Bank
AM3089	2 GHz	to	18 GHz	Switched Analog Tunable Bandpass Filter Bank
AM3063	6 GHz	to	18 GHz	Digitally Tunable Bandpass Filter Bank
AM3064	1 GHz	to	6.5 GHz	Digitally Tunable Bandpass Filter Bank
AM3066	12 GHz	to	26.5 GHz	Digitally Tunable Bandpass Filter Bank

AM3025A – Filter Bank

Miniature Transmit / Receive with Sub-Octave Filtering

9mm 24 Lead QFN Details

Package Drawing

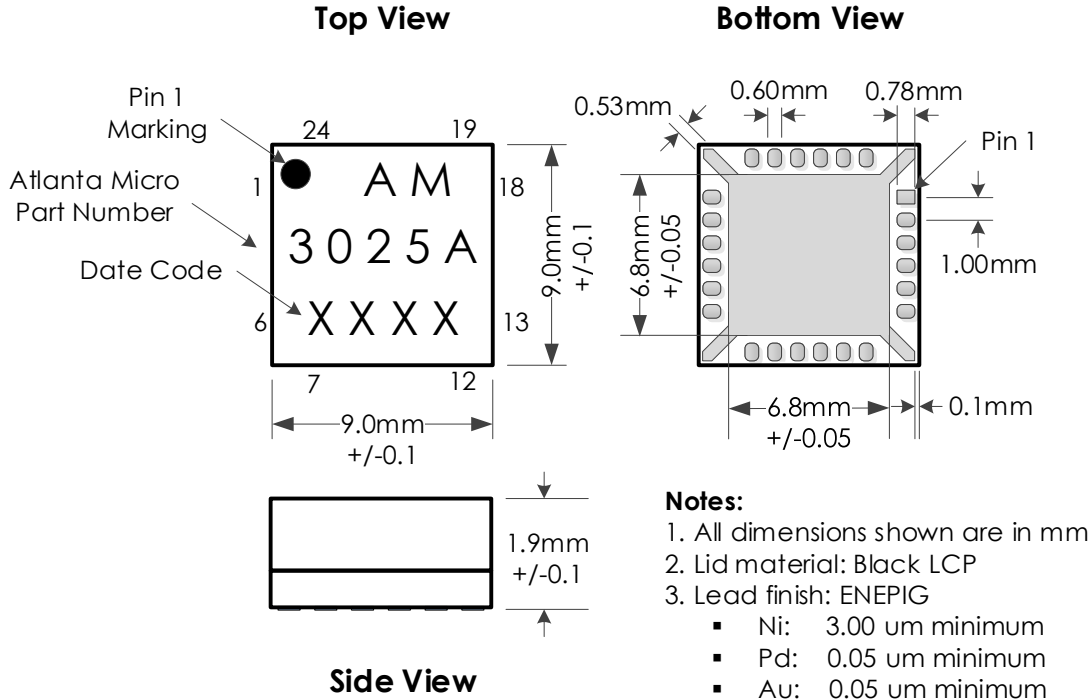

Recommended Footprint

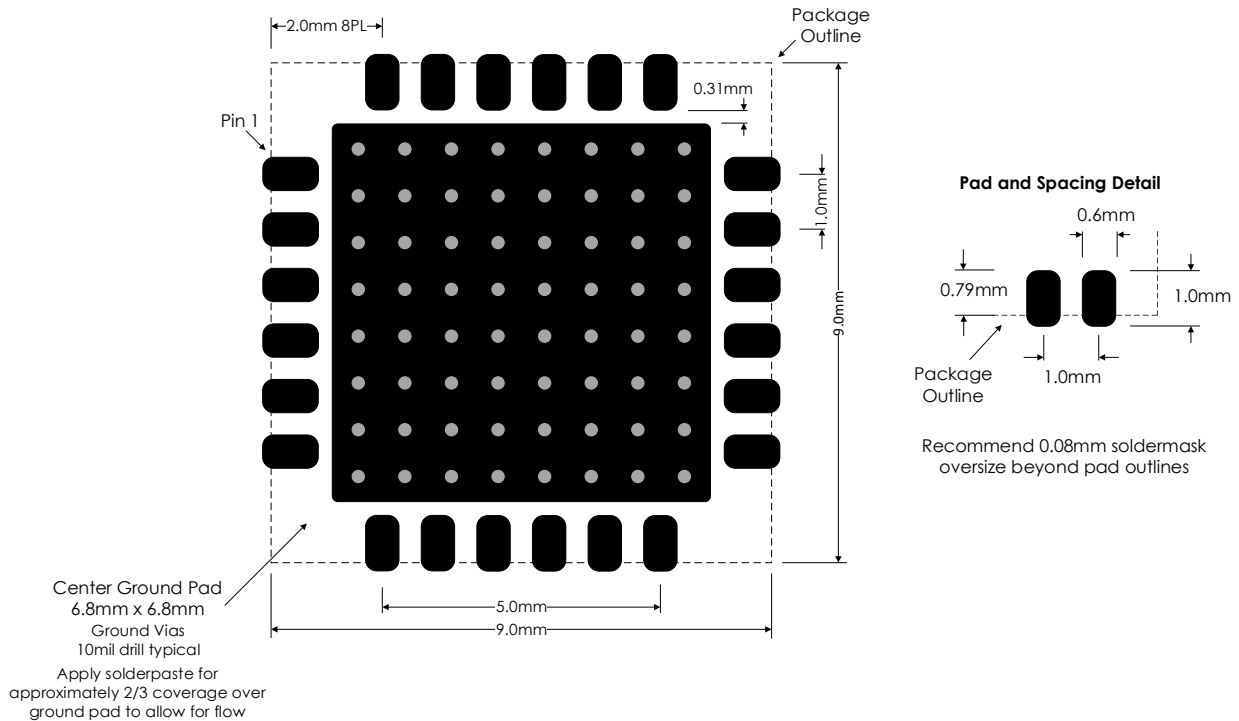

AM3025A – Filter Bank

Miniature Transmit / Receive with Sub-Octave Filtering

Evaluation PC Board Details

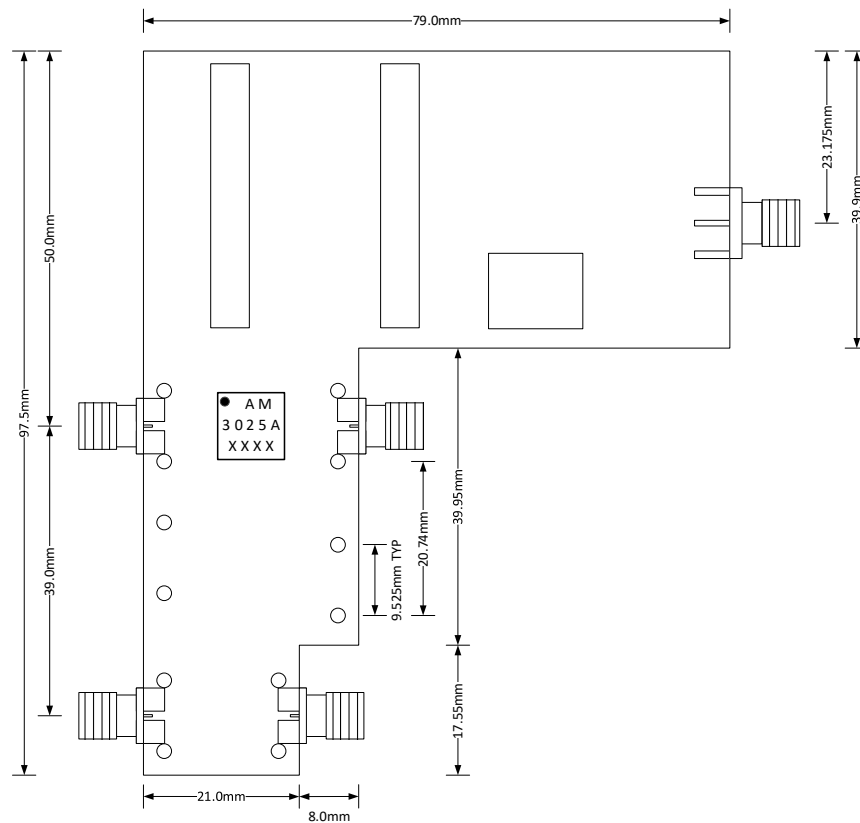
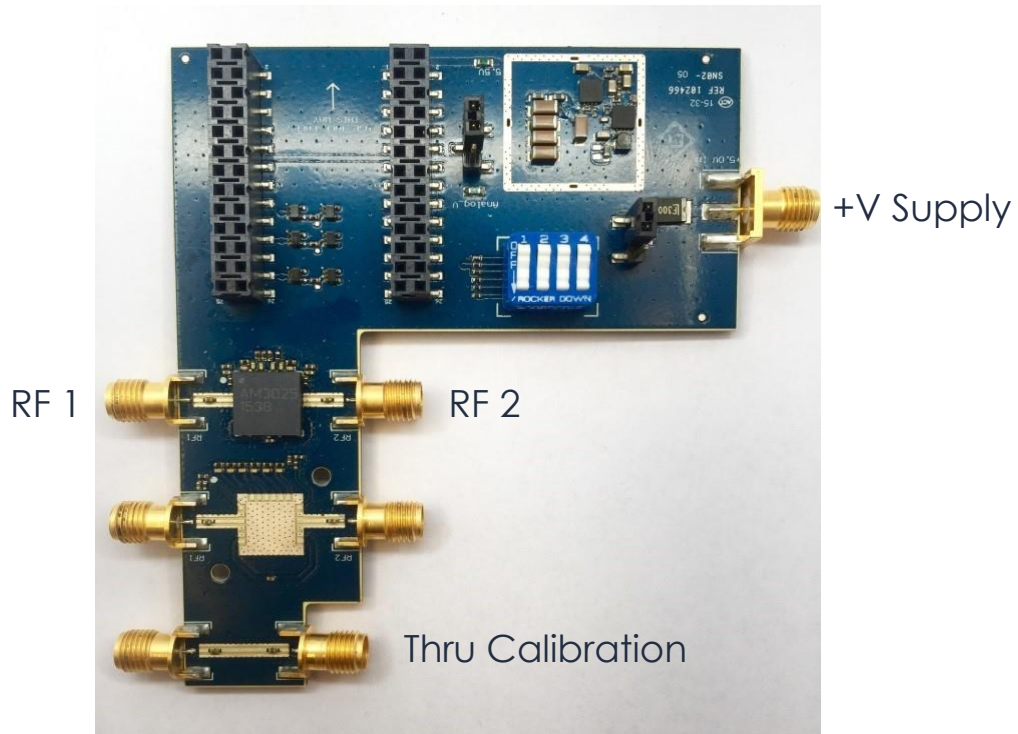

To obtain price, delivery, or to place an order contact sales@atlantamicro.com
 Atlanta Micro Inc., 3720 Davinci Ct, Suite 125, Norcross, GA 30092 • Phone: (470) 253-7640 • www.atlantamicro.com

AM3025A – Filter Bank

Miniature Transmit / Receive with Sub-Octave Filtering



RF Shielded Module Details



Top View

Bottom View

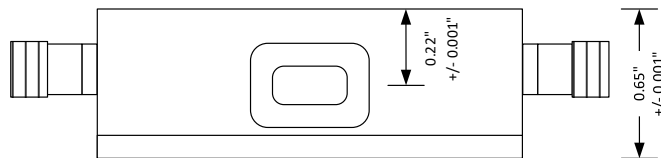
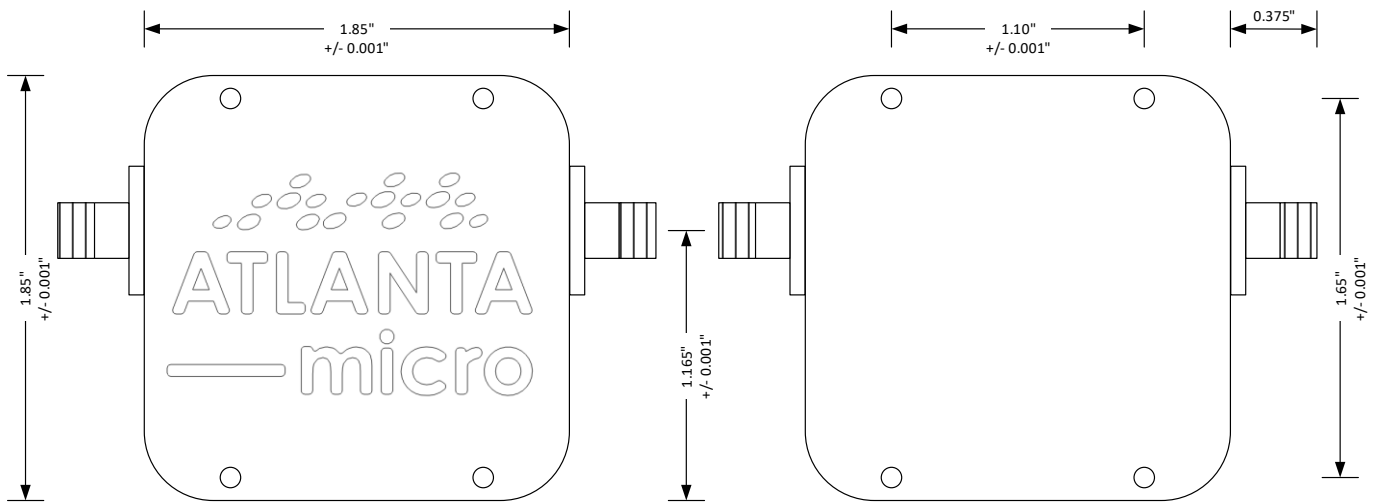

Front View

Notes:

- 1. All dimensions shown are in inches
- 2. Module material: Aluminum
- 3. Mounting Holes: 4-40 threaded on top side
- 4. RF I/O Interface: SMA
- 5. Power/control via Mini-USB

To obtain price, delivery, or to place an order contact sales@atlantamicro.com
Atlanta Micro Inc., 3720 Davinci Ct, Suite 125, Norcross, GA 30092 • Phone: (470) 253-7640 • www.atlantamicro.com

Component Compliance Information

RoHS: Atlanta Micro, Inc. hereby certifies that all products comply with the EC Directive 2011/65/EC on the Restriction of Hazardous Substances, commonly known as EU-RoHS 6 and 10. All products supplied by Atlanta Micro shall be compliant with the European Directive 2011/65/EC based on the following substance list.

Substance List	Allowable Maximum Concentration
Lead (Pb)	<1000 PPM (0.1% by weight)
Mercury (Hg)	<1000 PPM (0.1% by weight)
Cadmium (Cd)	<75 PPM (0.0075% by weight)
Hexavalent Chromium (CrVI)	<1000 PPM (0.1% by weight)
Polybrominated Biphenyls (PBB)	<1000 PPM (0.1% by weight)
Polybrominated Diphenyl ethers (PBDE)	<1000 PPM (0.1% by weight)
Decabromodiphenyl Deca BDE	<1000 PPM (0.1% by weight)
Bis (2-ethylhexyl) Phthalate (DEHP)	<1000 PPM (0.1% by weight)
Butyl Benzyl Phthalate (BBP)	<1000 PPM (0.1% by weight)
Dibutyl Phthalate (DBP)	<1000 PPM (0.1% by weight)
Diisobutyl Phthalate (DIBP)	<1000 PPM (0.1% by weight)

REACH: Atlanta Micro, Inc. neither uses nor intentionally adds any of the substances considered to be a Substance of Very High Concern (SVHC) as defined by the EU Regulation (EC) No. 1907-2006 on Registration, Evaluation, Authorization, and Restriction of Chemicals (REACH).

Conflict Materials: Atlanta Micro does not knowingly use materials that are sourced from the Democratic Republic of Congo (DRC) or any other known conflict regions. Atlanta Micro's supply chain is comprised of sources that are both environmentally and socially responsible. We periodically review this requirement with our vendors to ensure continued compliance.

Atlanta Micro takes its responsibility as a global partner seriously and will use due diligence within our supply chain to ensure all standards are met to the best of our knowledge.